

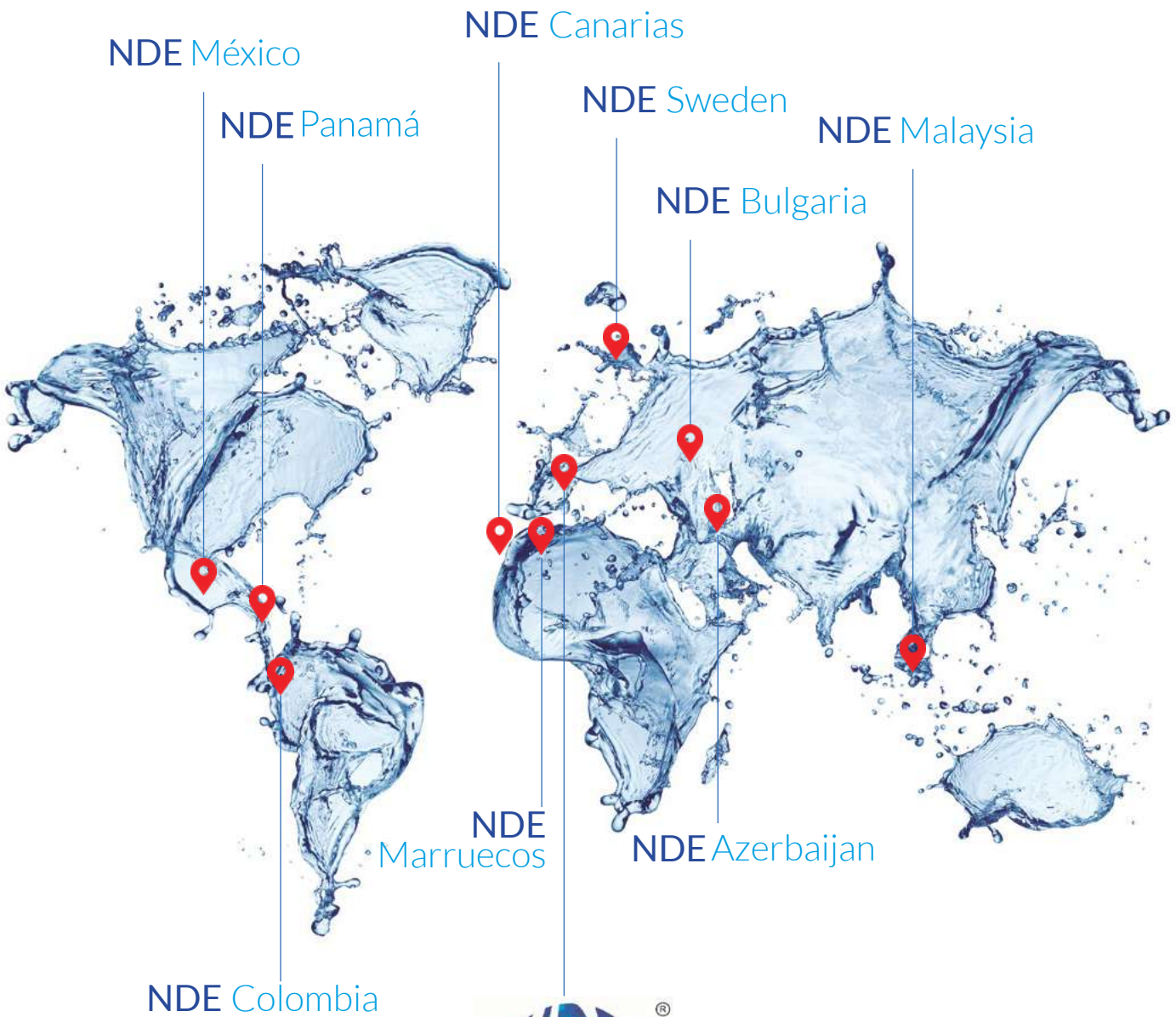

NDEPool®  
JUST ADD WATER





Headquarters Barcelona  
Spain





## Bienvenidos

Nuestro grupo es un holding de socios en los mercados internacionales con una experiencia acumulada de más de 25 años.

Nuestros productos están posicionados con nuestra propia marca registrada, NDEPool®. Le ofrecemos una gran variedad de productos de primera línea para piscina, climatización, wellness y parques acuáticos.

Dentro de NDEGroup® tenemos un gran equipo de profesionales a su disposición que le ayudarán a realizar cualquier tipo de proyecto.

Encontrará nuestros productos en muchos países, no sólo en Europa, sino que también en América del Sur y Central.

Calidad, profesionalidad y un servicio post-venta de trato muy cercano son nuestros principales valores para hacer crecer y fortalecer a nuestros clientes.

Quedamos a su disposición en nuestras delegaciones.

## Welcome

*Our group is a holding company of partners in international markets with an accumulated experience of more than 25 years.*

*Our products are positioned with our own registered brand NDEPool®. We offer a wide variety of products for swimming pools, heating systems, wellness and water parks.*

*Within NDEGroup®, we have a great team of professionals at your disposal, who will help you to carry out any type of project.*

*You will find our products in many countries, not only in Europe but also in Central and South America.*

*Quality, professionalism and after sales service with a very close treatment are our main values to help our customers to grow and strengthen.*

*We remain at your disposal at our branches.*

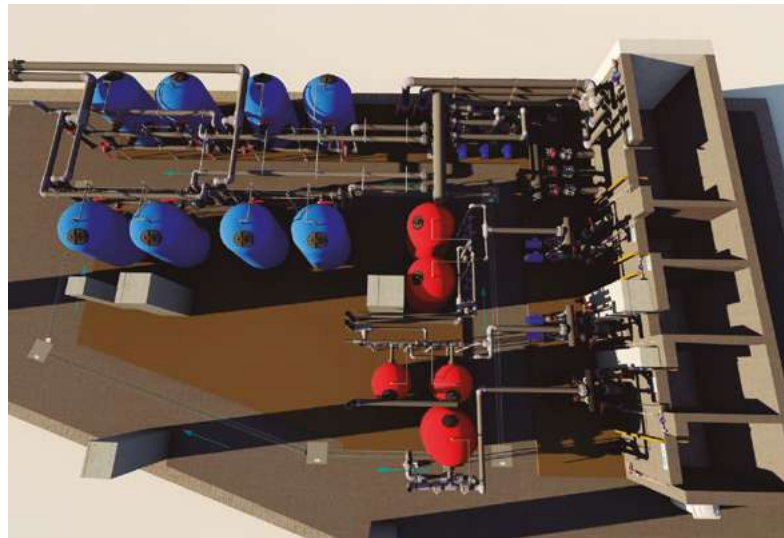

# ÍNDICE INDEX

## NDEPool

6

<b>FILTROS</b>   FILTERS	7
<b>BOMBAS</b>   PUMPS	29
<b>SOPLANTES</b>   BLOWERS	39
<b>MATERIAL DEL VASO Y EXTERIOR DE LA PISCINA</b>   POOL BASIN AND EXTERIOR EQUIPMENT	40
<b>ILUMINACIÓN</b>   POOL LIGHTING	77
<b>EQUIPOS DE DESINFECCIÓN Y CONTROL</b>   DISINFECTION AND CONTROL EQUIPMENT	82
<b>ACCESORIOS DE PVC</b>   PVC ACCESSORIES	95
<b>CLIMATIZACIÓN</b>   CLIMATIZATION 	97
<b>ACCESORIOS DE LIMPIEZA</b>   CLEANING ACCESSORIES	114
<b>MATERIAL DE ENTRENAMIENTO Y COMPETICIÓN</b>   TRAINING AND COMPETITION EQUIPMENT	121
<b>AUDIO</b>   AUDIO	128
<b>CUBIERTAS Y ENROLLADORES</b>   POOL COVERS, ENCLOSURES AND ROLLERS	129
<b>REVESTIMIENTOS</b>   POOL FINISHES	153
<b>TARIMAS</b>   DECKS	160
<b>LINER PERSONALIZADO</b>   PERSONALISED LINER	164

## NDEWellness

166

<b>CENTROS DE WELLNESS A MEDIDA</b>   CUSTOMISED WELLNESS CENTERS	168
<b>SAUNAS</b>   SAUNAS	170
<b>FRÍO Y CALOR</b>   HOT AND COLD	172
<b>SPAS DE HIDROMASAJE</b>   HYDROMASSAGE SPAS	173
<b>JUEGOS DE AGUA INOX</b>   STAINLESS STEEL WATER FEATURES	178
<b>VESTUARIOS</b>   CHANGING ROOMS	190
<b>GIMNASIO</b>   GYM	194

## NDEPlay

196

<b>PARQUES ACUÁTICOS</b>   WATER PARKS	198
<b>PARQUES TEMÁTICOS</b>   THEME PARKS	202

## NDEProject

204

Nuestro equipo de NDEPool cuenta con una amplia experiencia en el diseño, construcción y saneamiento de piscinas de competición.

Este tipo de piscinas deben cumplir con una serie de requisitos para poder pasar los certificados que permiten albergar competiciones de natación, waterpolo, saltos y natación sincronizada entre otros deportes acuáticos.

NDEPool le aconsejará durante todo el proyecto así como el suministro de equipamiento y accesorios.

NDEPool puede suministrar toda clase de maquinaria y materiales necesarios para su instalación.

Entre nuestros productos encontrarán filtros, bombas, material para el vaso, accesorios de PVC, bombas de calor, dosificadores, electrólisis salina, cobertores térmicos, cubiertas automáticas, juegos de agua y muchos más.

Todos nuestros productos son fabricados con un alto control de calidad de estándar Europeo.

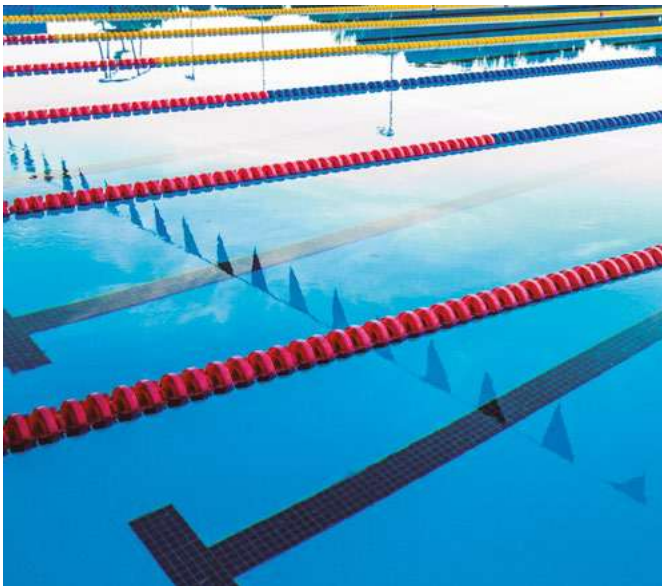

*Our NDEPool team has extensive experience in the design, construction and rehabilitation of competition pools.*

*This type of pool must need a series of requirements to be able to pass the certificates that allow swimming competition, water polo, diving and synchronised swimming, among other water sports.*

*NDEPool advises you throughout the process as well as can supply any equipment and accessories.*

*NDEPool also deals with the necessary machinery to filter, sanitize, acclimatise and illuminate swimming pools.*

*Among our products you will find filters, pumps, pool materials, PVC accessories, heat pums, dosifiers, salt electrolysis, thermal and automatic covers, water play products and many more.*

*All our products are produced to the highest European standard of quality control.*

# FILTROS FILTERS





## FILTROS FILTERS

### COMBO FMCO Bobinado

Conexiones no incluidas  
Connections not included

- Conjunto compacto formado por bomba+filtro bobinado. Diseñado para un fácil transporte y almacenaje.
- Perfecto para piscinas elevadas o de pequeñas dimensiones.
- Rápida instalación. Base incluida.
- Presión de trabajo máxima de 2,5 bar. Presión de prueba máxima 3,75 bar. Temperatura máxima de trabajo 40°C.
- Bomba con conexión 1,5" (50mm), clase IP55&F
- Disponibilidad de personalizar la combinación del filtro con la bomba.
- Alimentador de tabletas de cloro disponible.
- **Con válvula multipuerto de 6 vías incluida.**
- **Garantía tanque filtro 5 años.**



- *Set of modular bobbin wound+filter syste. Designed for easy storage and transportation.*
- *It is a perfect solution for temporary swimming pools.*
- *Quick installation. Base included.*
- *Maxim operating pressure 2,5 bar. Maxim test pressure 3,75 bar. Maxim operating temperature 40°C.*
- *Pump with 1,5" (50mm) connection, class IP55&F.*
- *Customization of filter and pump models pairing is available.*
- *Optional chlorine feeder.*
- ***With 6-way multiport valve included.***
- ***Filter tank warranty 5 years.***

Code	Pool Size (m <sup>3</sup> ) at 6h turnover	Filter (mm)	Multiport Valve (inches)	Filtration Area (m <sup>2</sup> )	Max Flow rate (m <sup>3</sup> /h)	Silica Sand (kg)	Pump (HP)	Power
FMCO350	29	350	1,5"	0.1	5.00	16	0.50	220-240 50/60Hz 1phase 2850rpm
FMCO400	38	400	1,5"	0.13	6.30	30	0.50	
FMCO450	48	450	1,5"	0.16	8.00	40	0.75	
FMCO550	69	550	1,5"	0.24	11.52	85	1.00	
FMCO650	97	650	1,5"	0.33	16.20	155	1.20	

# FILTROS FILTERS

## COMBO FMCO Dimensiones

Disponemos conexiones milimétricas (mm)/  
pulgadas (NPT). Voltaje 60Hz  
*We have milimetric (mm)/inches (NPT). Voltage 60Hz*

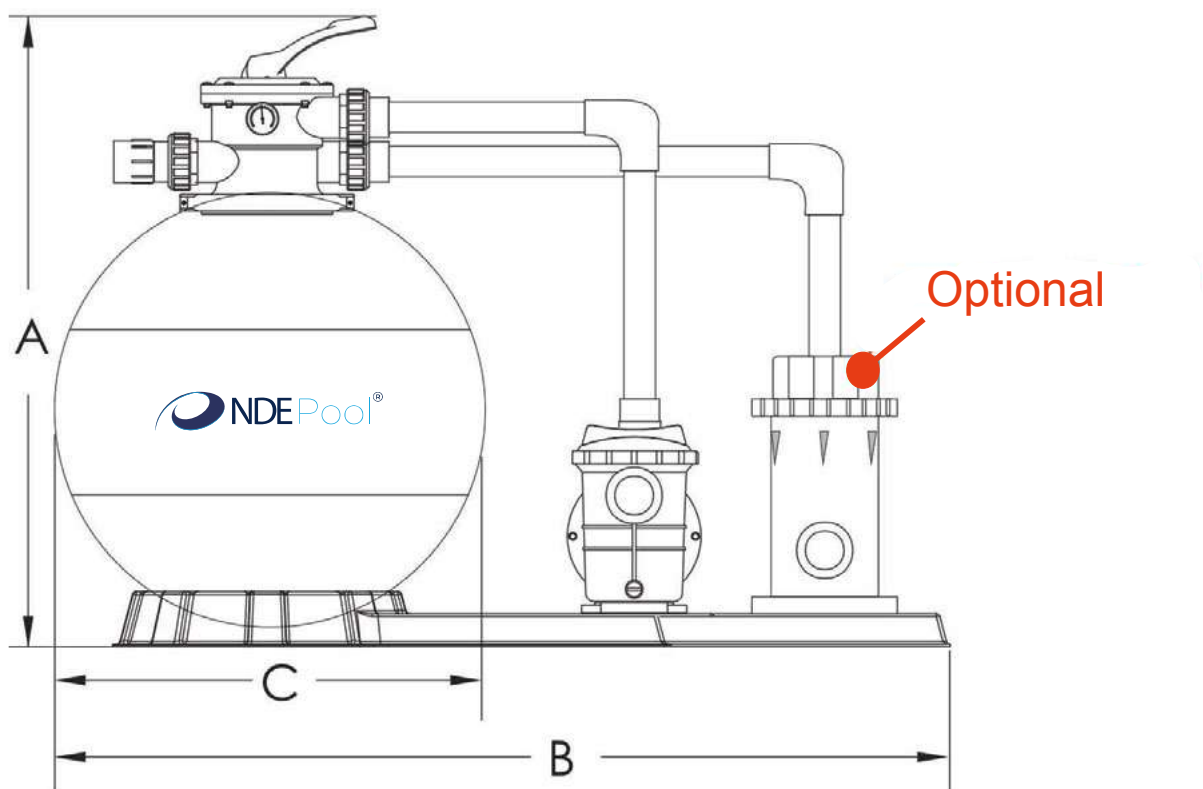

Opcional: Dosificador de cloro en tabletas  
*Optional: Chlorine tablet feeder*

MODEL	A (mm)	B (mm)	C (mm)
FMCO350	660	650	350
FMCO400	740	750	400
FMCO450	800	750	450
FMCO550	840	850	550
FMCO650	960	850	650

# FILTROS FILTERS

## APOLO FMBS Bobinado

- Filtro Bobinado con válvula lateral de 6 vías. Disponible desde 450mm a 1400mm diámetro. Doble capa en un tanque de fibra de vidrio con tecnología bobinada.
- Presión de trabajo máxima de 2,5 bar. Presión de prueba máxima 3,75 bar. Temperatura máxima de trabajo 40°C.
- 100% testados.
- Tapa opaca con tornillos inox.
- Válvula multipuerto de 6 vías.
- Mirilla para el contralavado.
- Colectores de distribución de 0,4mm.
- Manómetro de acero inoxidable.
- Base con número de serie y producción.
- **Garantía tanque filtro: 5 años.**

- *Bobbin side mounted fiberglass filter available from diameter 450 to 1400mm. Dual-layer fiberglass tank with crossover winding technology.*
- *Maxim operating pressure 2,5 bar. Maxim test pressure 3,75 bar. Maxim operating temperature 40°C.*
- *100% tested.*
- *Blink lid with bolt down style opening*
- *Superflow multiport 6 way valve.*



- *In-line backwash sight glass.*
- *0,4mm lateral distribution.*
- *Stainless steel with oil filled pressure gauge.*
- *Dependable base engraved with production date and serial number.*
- **Warranty Filter tank: 5 years.**

CODE	Diam. (mm)	MPV Size (inch)	MPV Size (mm)	Filter Area (m <sup>2</sup> )	Bed depth (mm)	Sand (kg)	Design Flow (m <sup>3</sup> /h)	Designed Velocity (m <sup>3</sup> /h/m <sup>2</sup> )	Max. Working Pressure (kpa)	Gross Weight (kg)
FMBS450	454	1.5	50	0.16	322	40	8	48	370	16.5
FMBS550	541	1.5	50	0.22	276	85	12	48	370	21.1
FMBS650	621	1.5	50	0.33	322	155	16	48	370	24.3
FMBS700	705	1.5	50	0.38	333.5	210	19	48	370	33
FMBS750	755	2	63	0.44	-	230	23	48	370	36
FMBS800	821	2	63	0.5	432	250	25	48	370	41.5
FMBS900	921	2	63	0.64	486	350	30	48	370	52.3
FMBS1000	1016	2	63	0.79	504	600	33	48	370	95
FMBS1100	1092	2	63	0.98	588	900	38	48	370	115
FMBS1200	1210	2	63	1.13	796.5	1150	42	48	370	124
FMBS1400	1404	2	63	1.54	796.5	1800	57	48	370	182.5

# FILTROS FILTERS

## APOLO FMBS Dimensiones

Disponemos conexiones milimétricas (mm)/pulgadas (NPT)  
*We have milimetric (mm)/inches (NPT)*

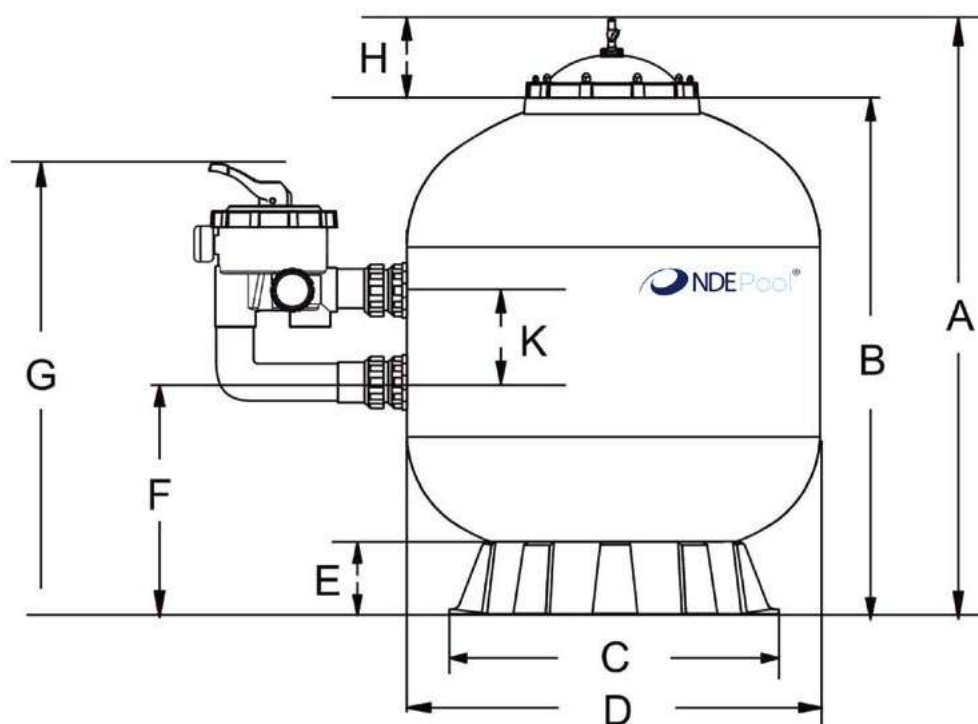

	FMBS450	FMBS550	FMBS650	FMBS700	FMBS800	FMBS900	FMBS1000	FMBS1100	FMBS1200	FMBS1400
A (mm)	668	732	833	903	1008	1115	1145	1320	1550	1595
B (mm)	538	602	703	733	878	1050	1068	1140	1240	1415
C (mm)	390	497	497	497	714	714	720	800	913	1200
D (mm)	454	541	621	705	821	921	1016	1092	1210	1404
E (mm)	75	90	90	90	125	125	150	150	170	200
F (mm)	239	254	310	350	361	405	475	530	635	635
G (mm)	564	576	634	675	786	846	900	960	1065	1065
H (mm)	130	130	130	130	130	130	130	130	130	130
K (mm)	125	125	125	125	195	195	195	195	195	195

# FILTROS FILTERS

## APOLO FMBT Bobinado

- Filtro Bobinado con válvula top de 6 vías. Disponible desde 350mm a 1400mm diámetro. Doble capa en un tanque de fibra de vidrio con tecnología bobinada.
- Presión de trabajo máxima de 2,5 bar. Presión de prueba máxima 3,75 bar. Temperatura máxima de trabajo 40°C.
- 100% testados.
- Válvula de 6 vías.
- Mirilla para el contralavado.
- Colectores de distribución de 0,4mm.
- Manómetro de acero inoxidable.
- Base con número de serie y producción.
- **Garantía tanque filtro: 5 años.**



- *Bobbin top mounted fiberglass filter available from diameter 350 to 1400mm. Dual-layer fiberglass tank with crossover winding technology.*
- *Maxim operating pressure 2,5 bar. Maxim test pressure 3,75 bar. Maxim operating temperature 40°C.*
- *100% tested.*
- *Superflow multiport valve.*

- *In-line backwash sight glass.*
- *0,4mm lateral distribution. (ask for optional nozzle System.*
- *Stainless steel with oil filled pressure gauge.*
- *Dependable base engraved with production date and serial number.*
- **Warranty Filter tank: 5 years.**

CODE	Diam. (mm)	MPV Size (inch)	MPV Size (mm)	Filter Area (m <sup>2</sup> )	Bed depth (mm)	Sand (kg)	Design Flow (m <sup>3</sup> /h)	Designed Velocity (m <sup>3</sup> /h/m <sup>2</sup> )	Max. Working Pressure (kpa)	Gross Weight (kg)
FMBT350	350	1.5	50	0.1	240	20	5	48	370	12
FMBT400	400	1.5	50	0.13	290	30	6	48	370	16
FMBT450	450	1.5	50	0.16	300	40	8	48	370	16.5
FMBT550	550	1.5	50	0.24	340	85	12	48	370	21.1
FMBT650	650	1.5	50	0.33	400	155	16	48	370	24.3
FMBT700	700	1.5	50	0.38	460	210	19	48	370	33
FMBT750	755	2	63	0.44	-	230	23	48	370	34
FMBT800	820	2	63	0.5	384	250	25	48	370	41.5
FMBT900	920	2	63	0.65	384	350	30	48	370	52.3
FMBT1000	1016	2	63	0.79	432	600	33	48	370	95
FMBT1100	1092	2	63	0.98	432	900	38	48	370	115
FMBT1200	1210	2	63	1.13	504	1150	42	48	370	124
FMBT1400	1404	2	63	1.54	708	1800	57	48	370	182.5

# FILTROS FILTERS

## APOLO FMBT Dimensiones

Disponemos conexiones milimétricas (mm)/pulgadas (NPT)

*We have milimetric (mm)/inches (NPT)*

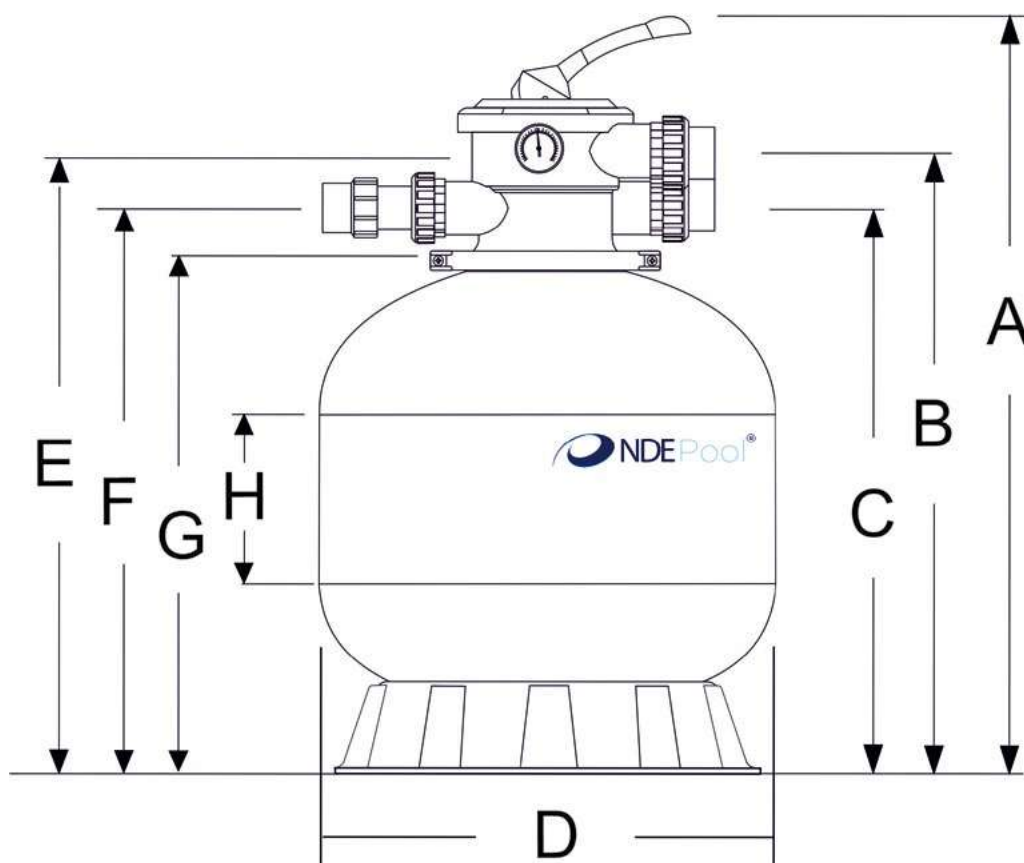

	FMBT350	FMBT400	FMBT450	FMBT550	FMBT650	FMBT700	FMBT800	FMBT900	FMBT1000	FMBT1100	FMBT1200	FMBT1400
A (mm)	680	770	810	867	967	1017	1180	1285	1406	1480	1500	1615
B (mm)	550	614	674	731	831	863	1026	1131	1252	1350	1450	1565
C (mm)	490	585	614	671	771	783	946	1051	1172	1270	1370	1485
D (mm)	390	390	390	497	497	497	714	720	720	800	913	1200
E (mm)	346	410	454	534	635	700	820	920	1016	1092	1210	1404
F (mm)	431	525	558	615	715	775	880	985	1106	1210	1310	1425
G (mm)	490	585	614	671	771	831	946	1051	1172	1270	1370	1485
H (mm)	550	641	674	731	831	891	1026	1131	1252	1340	1400	1575
I (mm)	175	230	280	240	280	290	320	320	360	360	420	590

## FILTROS FILTERS

### PLATON FMLS Laminado

- Filtro laminado con válvula lateral con resistencia a los rayos UV. Disponible desde Ø450 a 1200mm.
- Presión de trabajo máxima de 2,5 bar. Presión de prueba máxima 3,75 bar. Temperatura máxima de trabajo 40°C.
- 100% testados.
- Válvula lateral de 6 vías.
- Colector de distribución.
- Tapa opaca con tornillos inox.
- Purga de descompresión.
- Colectores de distribución de 0,4mm.
- Manómetro de acero inoxidable.
- Base con número de serie y producción.
- **Garantía tanque filtro: 5 años**

- *Side mounted laminated filter with UV resistant available from diameter 450 to 1200mm.*
- *Maxim operating pressure 2,5 bar. Maxim test pressure 3,75 bar. Maxim operating temperature 40°C.*
- *100% tested.*
- *Superflow side mounted multiport valve.*
- *Built-in diffuser for even water distribution.*
- *Blink lid with bolt down style opening*
- *Internal air relief.*
- *0,4mm lateral distribution.*
- *Stainless steel with oil filled pressure gauge.*
- *Dependable base engraved with production date and serial number.*
- **Warranty Filter tank: 5 years.**



CODE	Dia. (mm)	MPV Size (inch)	MPV Size (mm)	Filter area (m <sup>2</sup> )	Bed depth (mm)	Sand (kg)	Design flow (m <sup>3</sup> /h)	Designed Velocity (m <sup>3</sup> /h/m <sup>2</sup> )	Max. Working Pressure (kpa)	Gross Weight (kg)
FMLS450	454	1.5	40	0.16	322	40	8	48	370	16.5
FMLS550	541	1.5	40	0.22	276	85	12	48	370	21.1
FMLS650	621	1.5	40	0.33	322	155	16	48	370	24.3
FMLS700	705	1.5	40	0.38	333.5	210	19	48	370	33
FMLS750	755	2	63	0.44	-	230	23	48	370	36
FMLS800	821	2	50	0.5	432	250	25	48	370	41.5
FMLS900	921	2	50	0.64	432	350	30	48	370	52.3
FMLS1000	1016	2	50	0.79	486	600	33	48	370	95
FMLS1100	1092	2	50	0.98	504	900	38	48	370	115

# FILTROS FILTERS

## PLATON FMLS Dimensiones

Disponemos conexiones milimétricas (mm)/pulgadas (NPT)  
*We have milimetric (mm)/inches (NPT)*

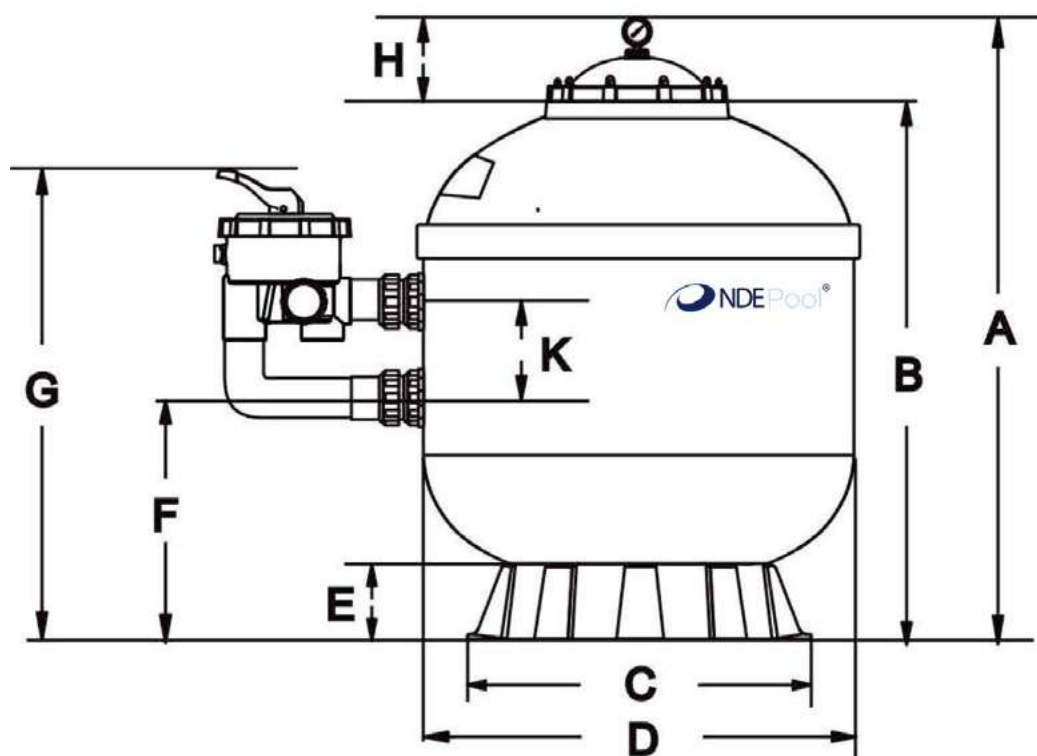

PLATÓN	FMLS450	FMLS550	FMLS650	FMLS700	FMLS800	FMLS900	FMLS1000	FMLS1100
A (mm)	668	732	833	903	1008	1115	1145	1320
B (mm)	538	602	703	733	878	1050	1068	1140
C (mm)	390	498	497	497	714	714	720	800
D (mm)	454	541	621	705	821	921	1016	1092
E (mm)	75	90	90	90	125	125	150	150
F (mm)	239	254	310	350	361	405	475	530
G (mm)	564	576	634	675	786	846	900	960
H (mm)	130	130	130	130	130	130	130	130
K (mm)	125	125	125	125	195	195	195	195



# FILTROS FILTERS

## PLATON FMLT Laminado

- Filtro laminado con válvula lateral con resistencia a los rayos UV. Disponible desde Ø400 a 1200mm.
  - Presión de trabajo máxima de 2,5 bar. Presión de prueba máxima 3,75 bar. Temperatura máxima de trabajo 40°C.
  - 100% testados.
  - Mirilla para el contralavado.
  - Colectores de distribución de 0,4mm.
  - Manómetro de acero inoxidable.
  - Base con número de serie y producción.
  - **Garantía tanque filtro: 5 años**
- 
- *Top mounted laminated filter with UV resistant available from diameter 400 to 1200mm.*
  - *Maxim operating pressure 2,5 bar. Maxim test pressure 3,75 bar. Maxim operating temperature 40°C.*
  - *100% tested.*
  - *Superflow top mounted multiport valve.*
  - *In-line backwash sight glass.*
  - *0,4mm lateral distribution.*
  - *Stainless steel with oil filled pressure gauge.*
  - *Dependable base engraved with production date and serial number.*
  - **Warranty Filter tank: 5 years.**



CODE	Diam. (mm)	MPV Size (inch)	MPV Size (mm)	FILTER AREA (m²)	Bed depth (mm)	Sand (kg)	DESIGN FLOW (m³/h)	Designed Velocity (m³/h/m²)	Max. Working Pressure (kpa)	Gross Weight (kg)
FMLT400	410	1.5	50	0.13	230	30	6	48	370	16.0
FMLT450	454	1.5	50	0.16	240	40	8	48	370	16.5
FMLT550	534	1.5	50	0.23	280	85	12	48	370	21.1
FMLT650	635	1.5	50	0.33	336	155	16	48	370	24.3
FMLT700	700	1.5	50	0.38	348	210	19	48	370	33.0
FMLT750	755	2	63	0.44	-	230	23	48	370	34
FMLT800	820	2	63	0.50	384	250	25	48	370	41.5
FMLT900	920	2	63	0.65	384	350	30	48	370	52.3
FMLT1000	1016	2	63	0.79	432	600	33	48	370	95.0
FMLT1100	1092	2	63	0.98	432	900	38	48	370	115.0
FMLT1200	1210	2	63	1.13	504	1150	42	48	370	124.0

# FILTROS FILTERS

## PLATON FMLT Dimensiones

Disponemos conexiones milimétricas (mm)/pulgadas (NPT)  
*We have milimetric (mm)/inches (NPT)*

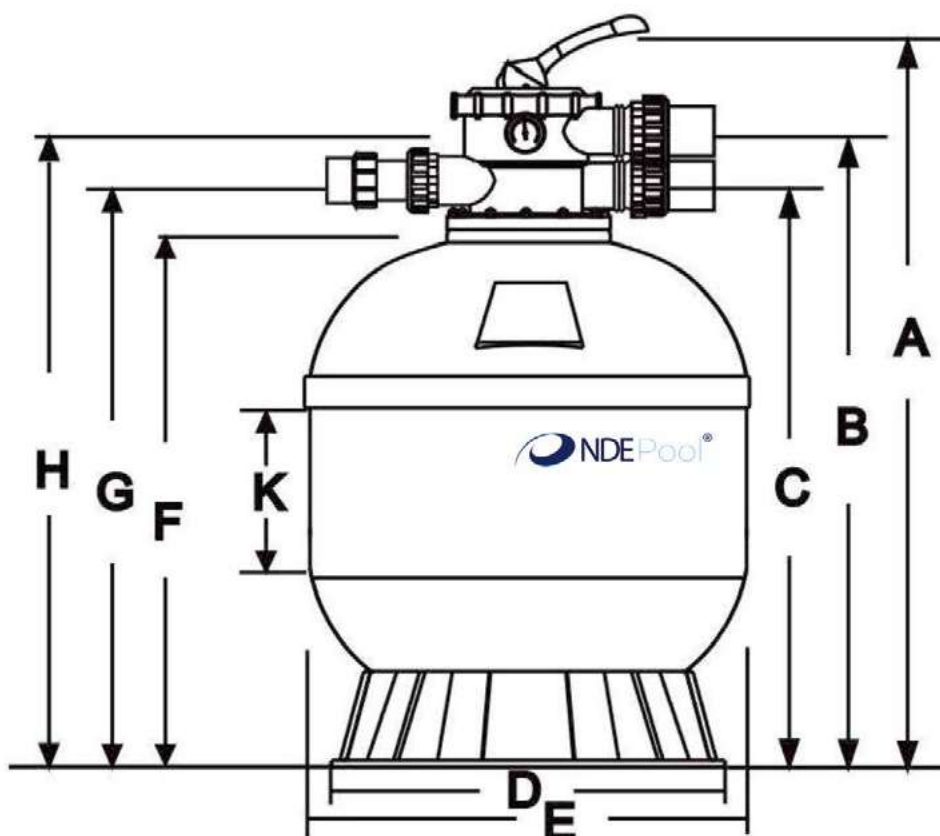

PLATÓN	FMLT400	FMLT450	FMLT550	FMLT650	FMLT700	FMLT800	FMLT900	FMLT1000	FMLT1100	FMLT1200
A (mm)	770	810	867	967	1027	1180	1285	1406	1480	1500
B (mm)	614	674	731	831	891	1026	1131	1252	1350	1450
C (mm)	585	614	671	771	831	946	1051	1172	1270	1370
D (mm)	390	390	497	497	497	714	720	720	800	913
E (mm)	410	454	534	635	700	820	920	1016	1092	121"
F (mm)	525	558	615	715	775	880	985	1106	1210	1310
G (mm)	585	614	471	771	831	946	1051	1172	1290	1370
H (mm)	641	674	731	831	891	1026	1131	1252	1340	1400
K (mm)	230	280	240	280	290	320	320	360	360	420

# FILTROS FILTERS

## VÁLVULA DE 6 VÍAS *MULTIPOINT VALVE*

- Para filtros residenciales tanto bobinados como laminados.
  - Diseñado para el máximo caudal y durabilidad. Tanto para aplicaciones domésticas como comerciales. Diferentes tamaños, para salida lateral y top.
  - Testados 100% para evitar fugas.
  - Uniones en medida métrica, disponible imperial.
  - Muelle y tornillería en acero inox. 316.
  - Máxima temperatura agua 40°C.
  - Máxima presión 4 bar (400kpa).
- 
- *For bobbin wound and laminated residential filters.*
  - *Designed for maximum flow and durability. Suitable for domestic and commercial application. Both top and side mounted and different sizes.*
  - *100% water pressure and leakage tested.*
  - *Unions sizes in Metric and Imperial standard available.*
  - *SS316 spring&screw.*
  - *Maximum wáter temperatura 40°C.*
  - *Maximum pressure 4 bar (400kpa).*



### 1.5" TOP & LATERAL 1,5" TOP & SIDE

- Doble salida presión para una instalación óptima.
  - Incluido: Unión con ángulo ajustable (hasta 15°).  
Mirilla en la salida desagüe  
Medidor de presión de aceite  
Uniones standard disponibles
- 
- *Dual-pressure gauge port for flexible installation*
  - *Included: Angle-adjustable unión (up to 15 degrees)*  
*In-line sight glass on waste output*  
*Dual oil pressure gauge*  
*Traditional unions upon request*

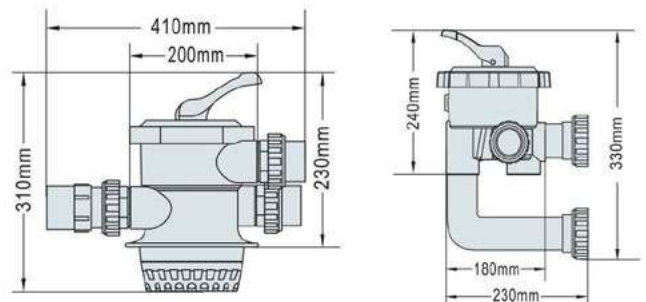

Code	Union Size	
	Imperial	Metric
FMVT15	1,5"	50mm
FMVS15	1,5"	50mm

# FILTROS FILTERS

## VÁLVULA DE 6 VÍAS VALVE *MULTIPOINT VALVE*

### 2.0" TOP & LATERAL 2.0" TOP & SIDE

- Includido: Unión con ángulo ajustable.  
Mirilla cilíndrica  
Medidor de presión de aceite  
Uniones estándar disponibles
- *Included: Angle-adjustable unión (up to 15 degrees)  
Cylinder type sight glass  
Dual oil pressure gauge  
Traditional unions upon request*



Code	Model	Inch (mm)
DM511	1,5" Metric	50mm
DM512	1,5" Imperial	1,5"
DM515	2,0" Metric	63mm
DM516	2,0" Imperial	2,0"

Code	Union Size	
	Imperial	Metric
FMVT20	2,0"	63mm
FMVS20	2,0"	63mm

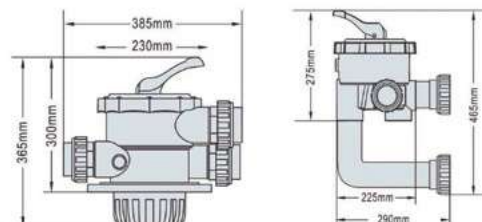
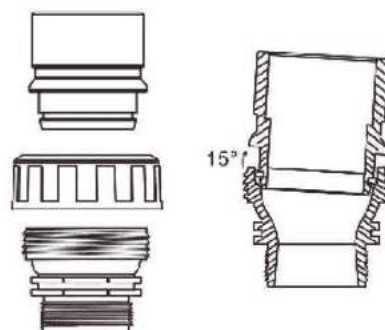

### 2.5" TOP & LATERAL 2.5" TOP & SIDE

- Includido: Uniones estándar disponibles  
Mirilla cilíndrica  
Medidor de presión de aceite
- *Included: Traditional unions upon request  
Cylinder type sight glass  
Dual oil pressure gauge*

Code	Union Size	
	Imperial	Metric
FMVT25	2,5"	75mm
FMVS25	2,5"	75mm

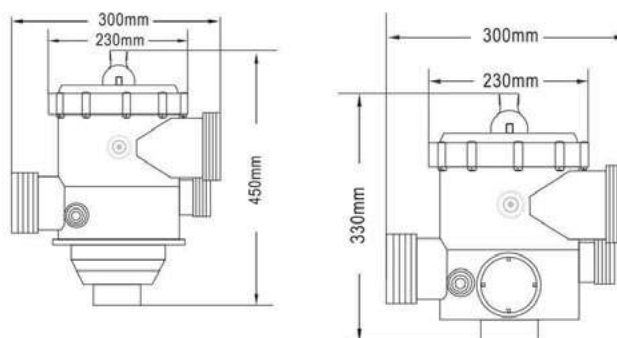

# FILTROS COMERCIALES COMMERCIAL FILTERS

## APOLO FMCV Bobinado

- Filtro Comercial Bobinado de fibra de vidrio. Disponible de 1200mm-3000 mm diámetro con opcionales (ver pág. 23).
- Presión de trabajo máxima de 2,5 bar. Presión de prueba máxima 3,75 bar. Temperatura máxima de trabajo 40°C. Disponible a 4,0 bar.
- Apertura superior de 520mm. Purga vaciado.
- Purga aire. Brazos colectores.
- 100% testados.
- Manómetro de fibra de vidrio con un panel doble de 80mm.
- Bridas de conexión DIN (disponible otro tipo).
- **Garantía tanque filtro: 5 años.**

- *Bobbin wound fiberglass commercial filter available from diameter 1200 to 3000mm with option features (see page 23).*
- *Maxim operating pressure 2,5 bar. Maxim test pressure 3,75 bar. Maxim operating temperature 40°C. Ask for 4,0 bar.*
- *520mm Top opening hatch. Water drain.*
- *Water air relief. Lateral collection system.*
- *100% tested.*
- *Fiberglass pressure gauge poanel with 80mm dual oil filled pressure gauge.*
- *Flange connections standard: DIN (available other).*
- **Warranty Filter tank: 5 years.**



CODE 2,5 bar	CODE 4,0 bar	Diam. (mm)	Connection size (mm)	Filter area (m <sup>2</sup> )	Designed Velocity (m <sup>3</sup> /h/m <sup>2</sup> )	Design flow (m <sup>3</sup> /h)	Flow rate (50m <sup>3</sup> /h/m <sup>2</sup> )	Media bed depth (m)	Gravel 1-1,2mm (kg)	Sand 0,4-0,8mm (kg)
FMCV1200	FMCP1200-4	1200	90	1.13	40	52	65	1.05	300	1375
FMCV1400	FMCP1400-4	1400	110	1.54	40	69	82	1.10	450	1650
FMCV1600	FMCP1600-4	1600	110	2.00	40	80	100	1.20	675	2150
FMCV1800	FMCP1800-4	1800	160	2.70	40	125	156	1.35	750	2800
FMCV2000	FMCP2000-4	2000	160	3.14	40	157	196	1.44	1050	3800
FMCV2300	FMCP2300-4	2300	200	4.30	40	217	271	1.48	1800	5275
FMCV2500	FMCP2500-4	2500	200	4.90	40	250	313	1.50	2200	5950
FMCV3000	FMCP3000-4	3000	250	7.07	40	353	441	2.50	3300	8600

# FILTROS COMERCIALES COMMERCIAL FILTERS

## APOLO FMCV Dimensiones

Disponemos conexiones milimétricas (mm)/pulgadas (NPT)  
*We have milimetric (mm)/inches (NPT)*

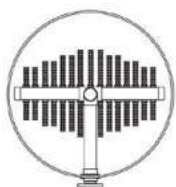

Standard Lateral System  
 F1200/F1400/F1600

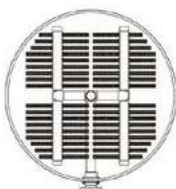

Standard Lateral System  
 F1800/F2000/F2300/  
 F2500/F3000

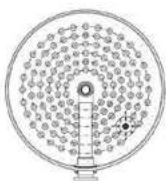

Optional Nozzle Plate

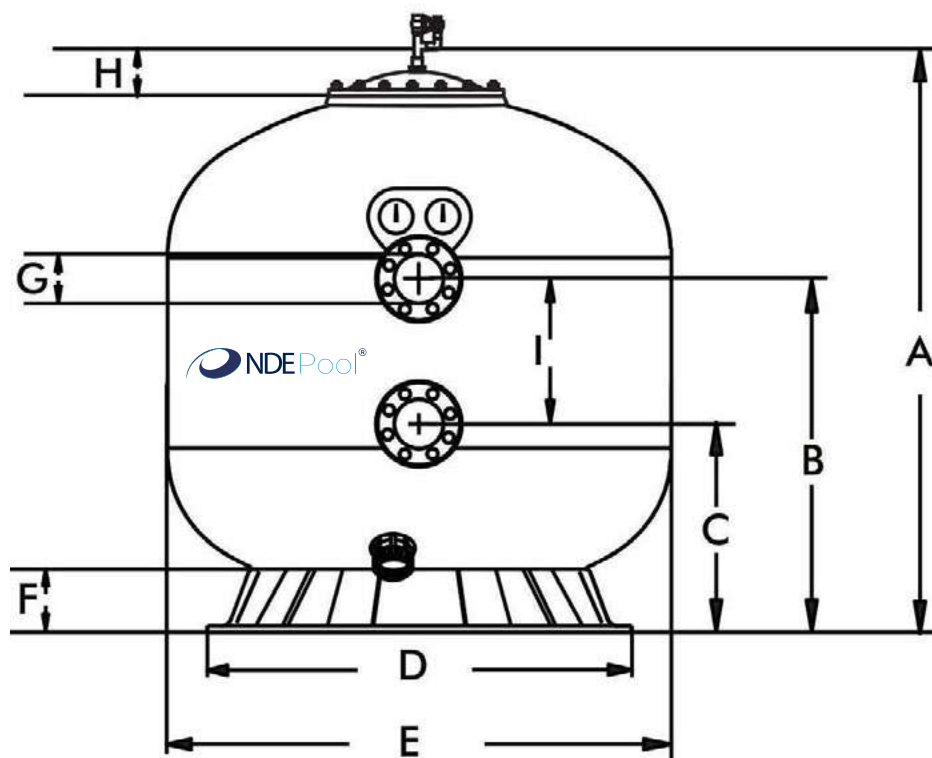

Diameter	1200	1400	1600	1800	2000	2300	2500	3000
A (mm)	1450	1520	1800	1900	2150	2350	2650	3040
B (mm)	900	1000	1100	1200	1340	1450	1610	1880
C (mm)	530	530	610	640	780	890	1050	1330
D (mm)	920	1210	1210	1440	1440	1950	1950	1950
E (mm)	1200	1400	1600	1800	2000	2300	2500	3000
F (mm)	170	180	180	230	230	280	280	280
G (mm)	80	100	100	150	150	200	200	250
H (mm)	100	100	100	100	100	100	100	100
I (mm)	360	470	470	560	560	560	560	560
J (mm)	230	300	300	350	350	500	500	700
K (mm)	700	760	800	900	960	980	1000	1650
L (mm)	350	380	400	450	480	500	500	850

# FILTROS COMERCIALES COMMERCIAL FILTERS

## APOLO FMCH Bobinado

- Filtro Horizontal Comercial Bobinado con fibra de vidrio. Disponible desde Ø1050 a 2500mm con opcionales (ver pág. 23).
  - Presión de trabajo máxima de 2,5 bar. Presión de prueba máxima 3,75 bar. Temperatura máxima de trabajo 40°C. Disponible a 4,0 bar.
  - Apertura superior de 520mm. Purga vaciado.
  - Purga aire. Brazos colectores.
  - 100% testados.
  - Manómetro de fibra de vidrio con panel doble de 80mm.
  - Solicite los opcionales (crepinas, mirilla, etc.).
  - **Garantía tanque filtro: 5 años.**
- *Bobbin wound Horizontal fiberglass commercial filter. Available from diameter 1050 to 2500mm with optionals (see page 23).*
  - *Working pressure of 2,5 - 4.0 bar. Maximum pressure of 4.0 and 6.0 bar. Maximum water temperature 40°C.*
  - *520mm Top opening hatch. Water drain.*
  - *Water air relief. Lateral collection system.*
  - *100% tested. Warranty of 5 years for the tank & 1 year for fittings.*
  - *Fiberglass pressure gauge panel with 80mm dual filled pressure gauge.*
  - *Ask for optionals (nozzle collection, sight glass, etc.).*
  - **Warranty Filter tank: 5 years.**



# FILTROS COMERCIALES COMMERCIAL FILTERS

## APOLO FMCH Bobinado

Disponemos conexiones milimétricas (mm)/pulgadas (NPT)  
We have milimetric (mm)/inches (NPT)

CODE	Diam. (mm)	Connections size (mm)	Overall Length (m)	Overall Height (m)	Designed Velocity (m <sup>3</sup> /h/m <sup>2</sup> )	Design Flow (m <sup>3</sup> /h)	Gross Weight (kg)	Gravel 1-1,2mm (kg)	Sand 0,4-0,8mm (kg)
FMCH1050-19	1050	90	1.9	1260	30	42	330	350	950
FMCH1050-23	1050	110	2.3	1260	20	64	380	475	1250
FMCH1050-25	1050	110	2.5	1260	20	70	420	575	1525
FMCH1050-27	1050	160	2.7	1260	40	75	500	700	1800
FMCH1050-30	1050	160	3.0	1260	40	84	540	775	2025
FMCH1200-25	1200	160	2.5	1500	40	106	400	700	1750
FMCH1200-30	1200	160	3.0	1500	40	129	450	925	2325
FMCH1400-25	1400	160	2.5	1700	40	121	470	800	2825
FMCH1400-30	1400	160	3.0	1700	30	147	550	1000	3450
FMCH1600-25	1600	160	2.5	1900	30	134	550	850	3875
FMCH1600-30	1600	160	3.0	1900	30	164	650	1050	4750
FMCH1800-25	1800	160	2.5	2100	30	150	917	975	4850
FMCH1800-30	1800	160	3.0	2100	30	183	1123	1225	5925
FMCH1800-35	1800	200	3.5	2100	30	216	1329	1475	7000
FMCH1800-40	1800	200	4.0	2100	30	250	1535	1700	8075
FMCH2000-25	2000	160	2.5	2300	30	130	1130	1050	5675
FMCH2000-30	2000	160	3.0	2300	30	212	1279	1300	8025
FMCH2000-35	2000	200	3.5	2300	40	250	1628	1550	9475
FMCH2000-40	2000	200	4.0	2300	40	288	1878	1800	12375
FMCH2000-45	2000	200	4.5	2300	30	320	2138	2075	12375
FMCH2300-30	2300	160	3.0	2600	20	238	1830	2575	9300
FMCH2300-35	2300	200	3.5	2600	40	282	2179	3125	11050
FMCH2300-40	2300	250	4.0	2600	40	320	2528	3650	12800
FMCH2300-45	2300	250	4.5	2600	40	350	2888	4200	14525
FMCH2300-50	2300	250	5.0	2600	40	380	3238	4750	16250
FMCH2500-35	2500	250	3.5	2800	20	300	2432	3175	11675
FMCH2500-40	2500	250	4.0	2800	40	335	2825	3725	11350
FMCH2500-45	2500	250	4.5	2800	30	380	3230	4300	15250
FMCH2500-50	2500	250	5.0	2800	30	410	3623	4850	17200



# FILTROS COMERCIALES COMMERCIAL FILTERS

## APOLO FMCH Dimensiones

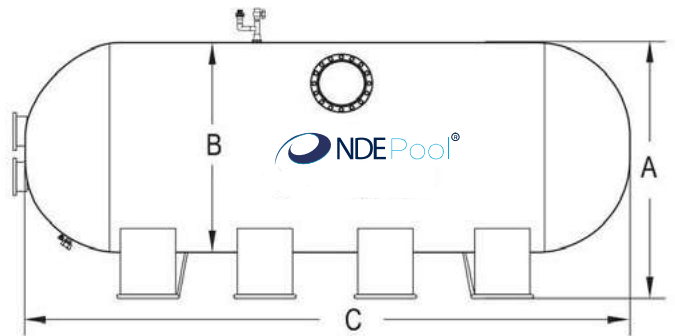
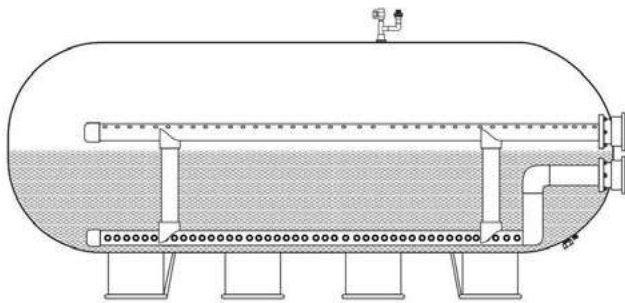

CODE	Height (mm)	Tank dia. (mm)	Length (mm)
FMCH1050-19	1260	1050	1900
FMCH1050-23	1260	1050	2300
FMCH1050-25	1260	1050	2500
FMCH1050-27	1260	1050	2700
FMCH1050-30	1260	1050	3000
FMCH1200-25	1500	1200	2500
FMCH1200-30	1500	1200	3000
FMCH1400-25	1700	1400	2500
FMCH1400-30	1700	1400	3000
FMCH1600-25	1900	1600	2500
FMCH1600-30	1900	1600	3000
FMCH1800-25	2100	1800	2500
FMCH1800-30	2100	1800	3000
FMCH1800-35	2100	1800	3500
FMCH1800-40	2100	1800	4000

CODE	Height (mm)	Tank dia. (mm)	Length (mm)
FMCH2000-25	2300	2000	2500
FMCH2000-30	2300	2000	3000
FMCH2000-35	2300	2000	3500
FMCH2000-40	2300	2000	4000
FMCH2000-45	2300	2000	4500
FMCH2300-30	2600	2300	3000
FMCH2300-35	2600	2300	3500
FMCH2300-40	2600	2300	4000
FMCH2300-45	2600	2300	4500
FMCH2300-50	2600	2300	5000
FMCH2500-35	2800	2500	3500
FMCH2500-40	2800	2500	4000
FMCH2500-45	2800	2500	4500
FMCH2500-50	2800	2500	5000

# FILTROS COMERCIALES COMMERCIAL FILTERS

## OPCIONES DE FILTROS COMERCIALES

Incluido de serie  
Standard inclusions

### OPTIONS COMMERCIAL FILTERS

## SISTEMA DE BRAZOS COLECTORES

### COLLECTION SYSTEMS

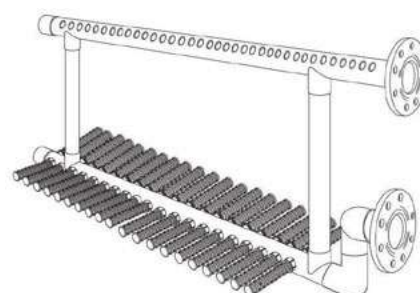

## PANEL DE PRESIÓN CON ACEITE

### GAUGE PANEL WITH OIL-FILLED

- Para filtros de la serie FMCV y FMCH.
- *For FMCV and FMCH series.*

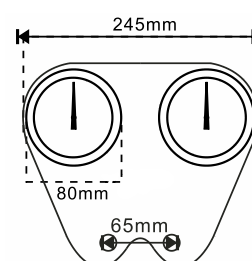

## VÁLVULA DE PURGA DE AIRE SMART AIR RELEASE VALVE

- Permite el vaciado del aire manualmente. Durante el vaciado del filtro, para presiones negativas la válvula de aire se abre automáticamente.
- *The valve can manually release the air inside the tank. Also, the one way valve is able to automatically release negative pressure during water drainage.*

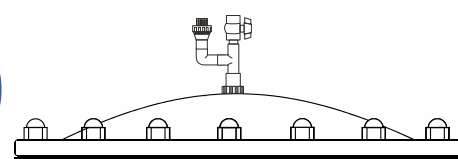

## VISOR (colocado encima del lecho filtrante)

### INTERNAL SIGHT GLASS (position above sand bed)

- Disponible en 2 medidas. Posición encima del lecho filtrante. Para filtros de la serie FMCV y FMCH.
- *Available in two sizes. Position above sand bed. For FMCV and FMCH series.*

Code	Inner Dia. (mm)	Outer Dia. (mm)
FMSG080	90	200
FMSG100	110	220

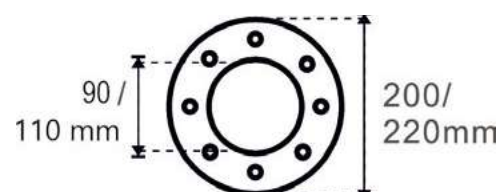

# FILTROS COMERCIALES COMMERCIAL FILTERS

## OPCIONES DE FILTROS COMERCIALES

### OPTIONS COMMERCIAL FILTERS

#### VISOR DE CONTRALAVADO INLINE SIGHT GLASS

- Para filtros de la serie FMCV y FMCH.
- For FMCV and FMCH series.

Code	Inner Dia. (mm)	Lenght (mm)
FMESG080	90	150
FMESG100	110	150
FMESG150	160	150
FMESG200	200	150

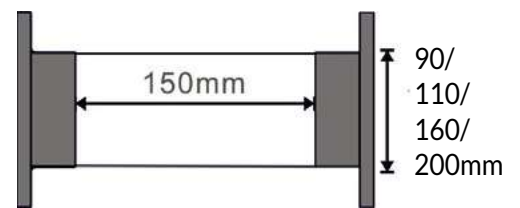

#### BOCA DE HOMBRE MANHOLE

- Para filtros de la serie FMCV y FMCH.
- For FMCV and FMCH series.

Code	Inner Dia. (mm)	Outer Dia. (mm)
FMMH400	400	520

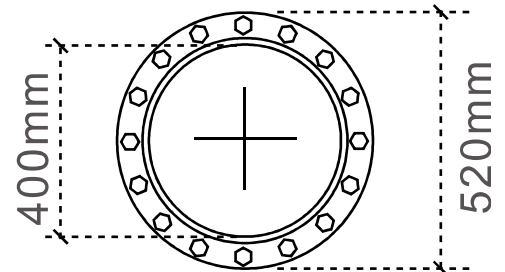

#### BATERIA DE VÁLVULAS VALVE MANIFOLD

- Para filtros de la serie FMCV y FMCH.
- For FMCV and FMCH series.

Code	Inner Dia. (mm)
FM5MF080	90
FM5MF100	110
FM5MF150	160
FM5MF200	200

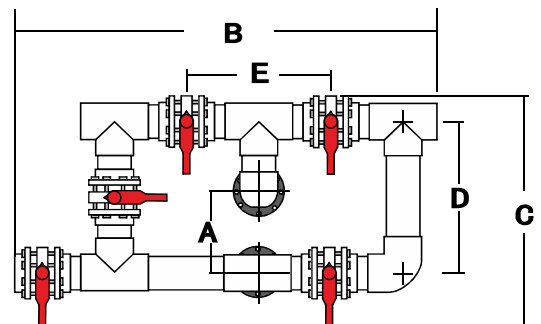

# FILTROS COMERCIALES COMMERCIAL FILTERS

## OPCIONES DE FILTROS COMERCIALES

### OPTIONS COMMERCIAL FILTERS

#### PLATO CREPINAS NOZZLE PLATE SYSTEM

- Para filtros de la serie FMCV solamente.
- *For FMCV series only.*

Code	Sand Filter
FMNP1200	1200
FMNP1400	1400
FMNP1600	1600
FMNP1800	1800
FMNP2000	2000
FMNP2300	2300
FMNP2500	2500
FMNP3000	3000

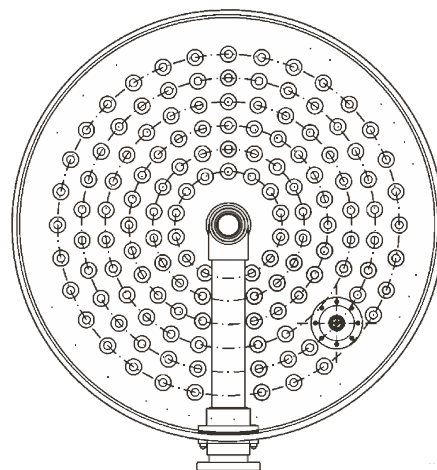

#### EXTENSIÓN LECHO FILTRANTE (500mm) ADDITIONAL BED DEPTH (500mm)

- Para filtros de la serie FMCV solamente.
- *For FMCV series only.*

Code	Sand Filter
FMBD1200	1200
FMBD1400	1400
FMBD1600	1600
FMBD1800	1800
FMBD2000	2000
FMBD2300	2300
FMBD2500	2500
FMBD3000	3000

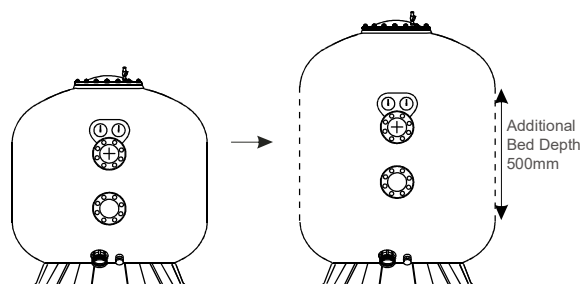

# FILTROS COMERCIALES COMMERCIAL FILTERS

## OPCIONES DE FILTROS COMERCIALES

### OPTIONS COMMERCIAL FILTERS

#### BRIDAS PVC PVC FLANGES

- Para filtros de la serie FMCV y FMCH.
- For FMC and FMH series.

Code	Inner Dia. (mm)
FMFG080	90
FMFG100	110
FMFG150	160
FMFG200	200

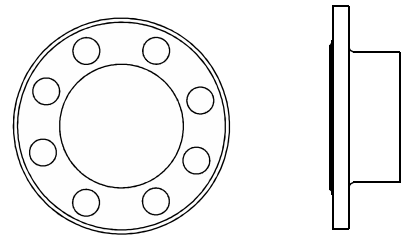

#### VÁVULAS DE MARIPOSA BUTTERFLY VALVES

Code	Inner Dia. (mm)
FMBV080	90
FMBV100	110
FMBV150	160
FMBV200	200

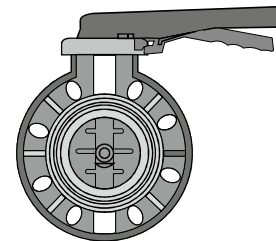



## BOMBAS PUMPS

# BOMBAS PUMPS

## HÉRCULES

- Bomba Ultra silenciosa.
- Motor resinado para una mayor protección.
- Eje en acero inoxidable AISI 316L.
- Rodamientos anti-vibración.
- Sellos de Vitón: excelente resistencia a los productos químicos.
- Sellado mecánico de carburo de silicio.
- Turbina en Noryl con fibra de vidrio.
- Diseñado para trabajar a altas temperaturas: máx. 60°C.
- Aislamiento clase F.
- Resistente a la cloración salina y agua de mar.
- Suministrado con uniones de  $\varnothing 50$  mm, succión y descarga con rosca 1½”.
- Todos los motores se suministran con protección térmica.



CE

Disponemos conexiones milimétricas (mm) / pulgadas (NPT). Voltaje 50/60Hz.

We have milimetric (mm)/inches (NPT). Volatge 50hz/60Hz.

- Ultra-silent pump.
- Resined motor for ultimate protection.
- Shaft in stainless steel AISI 316L.
- Anti-vibration bearings.
- Viton seals: excellent resistance to chemical agents.
- Silicon carbide mechanical seal.
- Impeller in Noryl with fiberglass.
- Designed to work at high temperatures max 60° C.
- Insulation class F.
- Resistant to salt treatment and sea water.
- Supplied with unions:  $\varnothing 50$ mm, thread of 1½”.
- All motors with thermal protection.

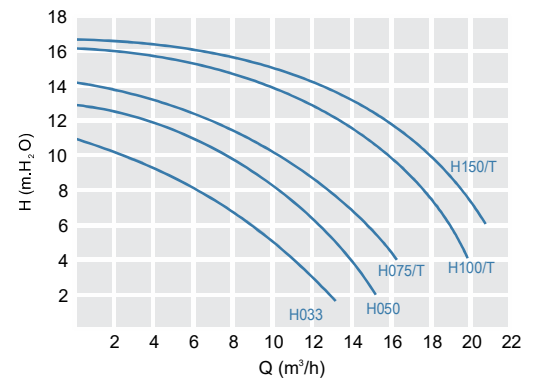
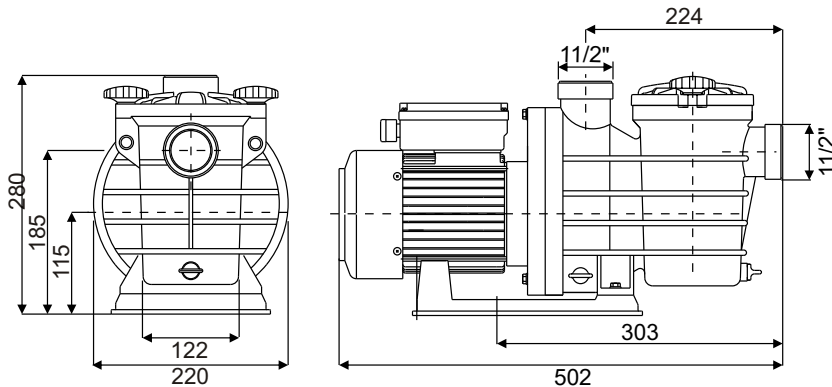

CODE	Power (hp)	Power (kW)	Intensity (A)	Voltage 50hz	Weight (Kg)	Packaging Size LxWxH (mm)
NDE-H033M	0,35	0,25	1,6	220-240	8,10	635 x 225 x 325
NDE-H050M	0,50	0,37	2	220-240	9,30	
NDE-H075M	0,75	0,55	3,2	220-240	10,60	
NDE-H075T	0,75	0,55	$\Delta 1,7/Y1,0$	230/400	10,60	
NDE-H100M	1,00	0,75	3,8	220-240	11,40	
NDE-H100T	1,00	0,75	$\Delta 2,4/Y1,4$	230/400	11,40	
NDE-H150M	1,50	1,1	5,8	220-240	12,80	
NDE-H150T	1,50	1,1	$\Delta 3,6/Y2,1$	230/400	12,80	

# BOMBAS PUMPS

## PEGASO

- Bomba Ultra silenciosa.
- Motor resinado para una mayor protección.
- Eje en acero inoxidable AISI 316L.
- Rodamientos anti-vibración.
- Sellos de Vitón: excelente resistencia a los productos químicos.
- Sellado mecánico de carburo de silicio.
- Turbina en Noryl con fibra de vidrio.
- Diseñado para trabajar a altas temperaturas: máx. 60°C.
- Aislamiento clase F.
- Resistente a la cloración salina y agua de mar.
- Suministrado con uniones de  $\varnothing 63$  mm, succión y descarga con rosca 2".
- Todos los motores se suministran con protección térmica.



CE

Disponemos conexiones milimétricas (mm) / pulgadas (NPT). Voltaje 50/60Hz.

We have milimetric (mm)/ inches (NPT). Volatge 50hz/60Hz.

- Ultra-silent pump.
- Resined motor for ultimate protection.
- Shaft in stainless steel AISI 316L.
- Anti-vibration bearings.
- Viton seals: excellent resistance to chemical agents.
- Silicon carbide mechanical seal.
- Impeller in Noryl with fiberglass.
- Designed to work at high temperatures max 60° C.
- Insulation class F.
- Resistant to salt treatment and sea water.
- Supplied with unions:  $\varnothing 63$ mm, thread of 2".
- All motors with thermal protection.

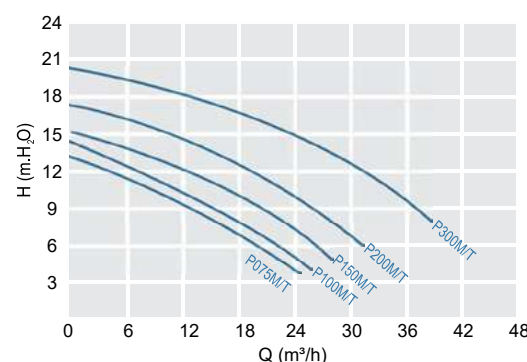
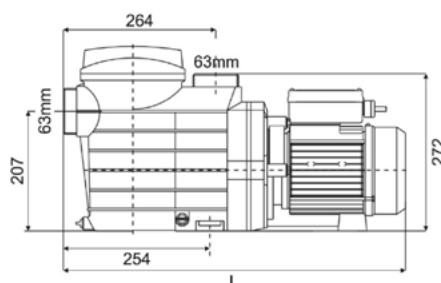
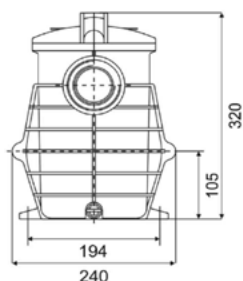

CODE	Power (hp)	Power (kW)	LEVEL dBA	Intensity (A)	Voltage 50hz	L (mm)	Weight (Kg)	Packaging Size LxWxH (mm)
NDE-P075M	0,75	0,55	60	3,2	220-240	628	14,6	625x275x350
NDE-P075T	0,75	0,55	60	$\Delta 1,7/Y1,0$	230/400	628	14,6	
NDE-P100M	1,00	0,75	64	3,8	220-240	628	16,0	
NDE-P100T	1,00	0,75	64	$\Delta 2,4/Y1,4$	230/400	628	16,0	
NDE-P150M	1,50	1,10	68	5,2	220-240	628	17,3	
NDE-P150T	1,50	1,10	68	$\Delta 3,6/Y2,1$	230/400	628	17,3	
NDE-P200M	2,00	1,50	72	7,0	220-240	628	21,0	670x275x350
NDE-P200T	2,00	1,50	72	$\Delta 4,5/Y2,6$	230/400	628	21,0	
NDE-P300M	3,00	2,20	75	10,0	220-240	646	24,1	
NDE-P300T	3,00	2,20	75	$\Delta 7,1/Y4,1$	230/400	646	24,1	



# BOMBAS PUMPS

## PEGASO PLUS

- Bomba Ultra silenciosa y robusta para piscinas residenciales con Cloración salina o agua de mar.
- Disponible de 0,75 a 4,0 Cv. Monofásicas y Trifásicas 50-60Hz.
- Motor resinado para una mayor protección.
- Eje en acero inoxidable AISI 316L y aro de acero inox. en la entrada y salida.
- Rodamientos anti-vibración.
- Sellos de Vitón: excelente resistencia a los productos químicos. Sellado mecánico de carburo de silicio. Turbina en Noryl con fibra de vidrio.
- Diseñado para trabajar a altas temperaturas (50°C) agua de mar y cloración salina
- Aislamiento clase F.
- Resistente a la cloración salina y agua de mar. Suministrado con uniones de  $\varnothing 63$  mm.
- Todos los motores se suministran con protección térmica.



Disponemos conexiones milimétricas (mm) / pulgadas (NPT). Voltaje 50/60Hz.

*We have milimetric (mm)/ inches (NPT). Volatge 50hz/60Hz.*

- Ultra-silent and robust residential pump. Ideal for salt chlorinators or sea water.
- Resined motor for ultimate protection.
- Shaft in stainless steel AISI 316L. Inlet&outlet are reinforced with stainless Steel ring.
- Anti-vibration bearings.
- Viton seals: excellent resistance to chemical agents. Silicon carbide mechanical seal. Impeller in Noryl with fiberglass.
- Designed to work at high temperatures max 60°C with salt sea wáter and salt chlorinator.
- Insulation class F. Supplied with unions:  $\varnothing 63$  mm.
- All motors with thermal protection.

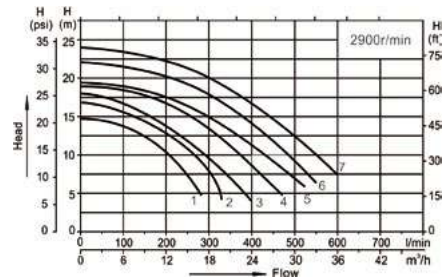
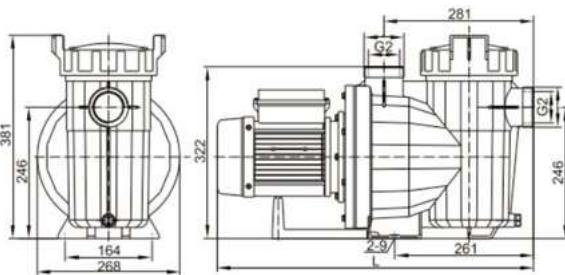

CURVE	CODE	Power (hp)	Voltatge 50hz	Intensity (A)	Connection mm	L mm	Weight (Kg)	Packaging Size LxWxH (mm)
1	NDE-PP075	0,75	220-240	3,2	63mm	576	14,6	615 x 300 x 440
1	NDE-PP075	0,75	220-240	$\Delta 1,7/Y1,0$	63mm	576	14,6	615 x 300 x 440
2	NDE-PP100	1,00	220-240	3,8	63mm	576	15,5	615 x 300 x 440
2	NDE-PP100	1,00	230/400	$\Delta 2,4/Y1,4$	63mm	576	15,5	615 x 300 x 440
3	NDE-PP150	1,50	220-240	5,2	63mm	576	16,5	615 x 300 x 440
3	NDE-PP150	1,50	230/400	$\Delta 3,6/Y2,1$	63mm	576	16,5	615 x 300 x 440
4	NDE-PP200	2,00	220-240	7,0	63mm	595	18,8	635 x 300 x 440
4	NDE-PP200	2,00	230/400	$\Delta 4,5/Y2,6$	63mm	595	18,8	635 x 300 x 440
5	NDE-PP250	2,50	220-240	8,6	63mm	595	20,5	635 x 300 x 440
5	NDE-PP250	2,50	230/400		63mm	595	20,5	635 x 300 x 440
6	NDE-PP300	3,00	220-240	10	63mm	595	22,0	635 x 300 x 440
6	NDE-PP300	3,00	230/400	$\Delta 7,1/Y4,1$	63mm	595	22,0	635 x 300 x 440
7	NDE-PP400	4,00	220-240	14	63mm	636	25,3	635 x 300 x 440
7	NDE-PP400	4,00	230/400		63mm	636	25,3	675 x 300 x 440

# BOMBAS VELOCIDAD VARIABLE VARIABLE SPEED PUMPS

## PEGASO VS

- Bomba Ultra silenciosa y robusta para piscinas residenciales con cloración salina y/o agua de mar hasta temperaturas de 60°C. Monofásica (50-60Hz).
- Disponible hasta 4,00 Cv.
- Con control de la velocidad variable a través del panel de control
- Ajuste de velocidad. Vel1: 3.000rpm; Vel2: 2.200rpm; Vel3: 1.400rpm o escoja su velocidad entre 450 - 3.450rpm en modo manual.
- Se puede encender y parar con control externo o con comunicación RS485.
- Motor resinado para una mayor protección.
- Eje en acero inoxidable AISI 316L.
- Rodamientos anti-vibratorios.
- Aislamiento clase F.
- Sellos de Vitón: excelente resistencia a los productos químicos. Sellado mecánico de carburo silicio. Turbina en Noryl con fibra de vidrio.
- Aislamiento clase F. Suministrado con uniones de Ø63mm, succión y descarga con rosca 2".
- Todos los motores se suministran con protección térmica.



CE

Disponemos conexiones milimétricas (mm) / pulgadas (NPT).  
We have milimetric (mm)/ inches (NPT).

- Ultra-silent and robust residential pump. Ideal for salt chlorinators and/or sea water up to 60°C.
- Monophasic (50-60Hz). Available up to 4,00 Hp
- Adopt V/F mode controller to realize the speed control function.
- Automatic and manual mode.
- Speed configuration: Speed1: 3.000rpm; speed2: 2.200 rpm; Speed3: 1.400rpm or choose your own speed between 450 - 3.450rpm in manual mode.
- It can be started or stopped by external keyboard or RS485 communication.
- Resined motor for ultimate protection
- Shaft in stainless steel AISI 316L.
- Anti-vibration bearings.
- Viton seals: excellent resistance to chemical agents.
- Silicon carbide mechanical seal Impeller in Noryl with fiberglass.
- Insulation class F. Supplied with unions: Ø63 mm,
- Resistant to salt treatment and sea water.
- All motors with thermal protection.

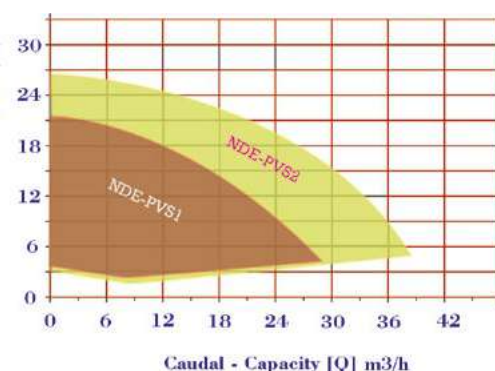
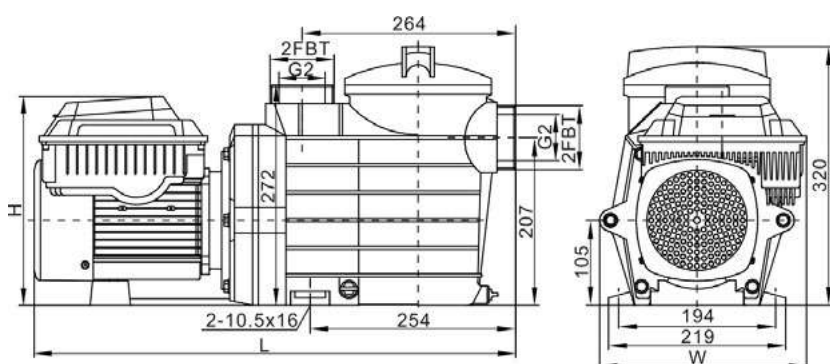

CODE	Power (hp)	Voltage 50hz or 60hz	Intensity (A)	SPEED r/min	Weight (Kg)	Packaging Size LxWxH (mm)	PACKING LxWxH mm
NDE-PVS1	2,2	115/208-230	13,8/ 8,5-7,4	450 -3450	21	595x255x258	660x310x415
NDE-PVS2	3,95	230	16	451 -3450	25,8	632x261x266	700x310x415

# BOMBAS PUMPS

## PEGASO MAX



CE

Disponemos conexiones milimétricas (mm) / pulgadas (NPT). Voltaje 50/60Hz.  
We have milimetric (mm)/ inches (NPT). Volatge 50hz/60Hz.

- Bomba comercial robusta auto-aspirante con cuerpo anticorrosivo de plástico con base de plástico para piscina comercial de gran potencia.
- Trifásicas 50-60Hz. Disponible de 3,0 a 10,0CV a 2.900 rpm
- Motor de alta eficiencia y ahorro energético.
- Temperatura de trabajo de 0°C a 75°C. Máxima presión de trabajo de 0,7MPa.Sellos de Vitón: excelente resistencia a los productos químicos.
- Para todo tipo de aguas grises, residuales e incluso para líquidos con ácidos.

- *Self-priming robust commercial pump Body is made of corrosion residential plastic with integrated plastic mounting base plate.*
- *Triphasic 50-60Hz. Available from 3,0Hp to 10,0Hp at 2.900 rpm.*
- *Equipped with high-efficiency motor, energy saving and long service life.*
- *Working temperature from 0°C to 75°C. Maximum working pressure of 0,7MPa.*
- *It is suitable for all kinds of waste water, sewage treatment and various acid-base liquid transportation.*

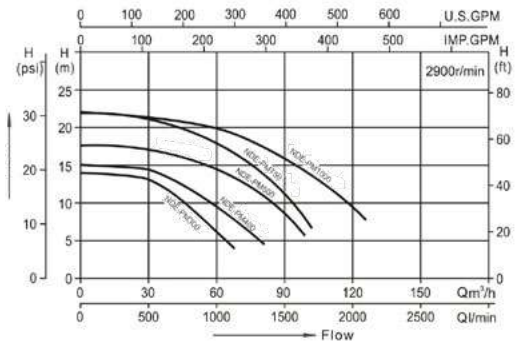
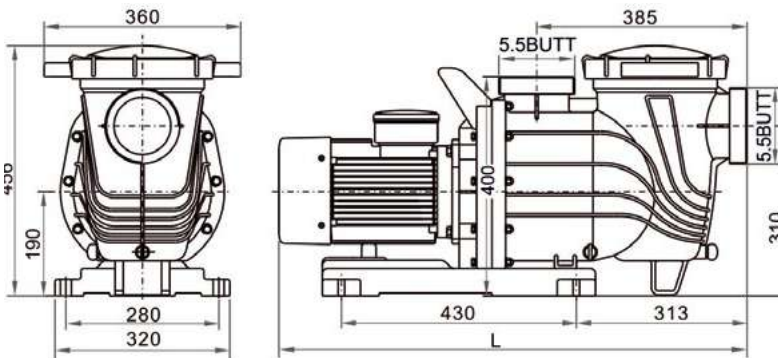

CODE	Power (hp)	Voltage 50hz or 60hz	Intensity (A)	CONNECTIONS mm/inches	Weight (Kg)	PACKING LxWxH mm	L mm
NDE-PM300M	3,00	220V/1Ph	4,1	90 / 3" 110 / 4"	45,5	840x395x600	800
NDE-PM300T	3,00	380V/3Ps	4,1		45,5	840x395x600	800
NDE-PM400M	4,00	220V/1Ph	5,2		47,0	840x395x600	800
NDE-PM400T	4,00	380V/3Ps	5,2		47,0	840x395x600	800
NDE-PM500T	5,00	380V/3Ps	8,2		54,5	930x395x600	857
NDE-PM750T	7,50	380V/3Ps	9,6		60,3	930x395x600	857
NDE-PM1000T	10,00	380V/3Ps	11,1		64,5	930x395x600	857

# BOMBAS COMERCIALES COMMERCIAL PUMPS

## ZEUS POWER



CE

Disponemos conexiones milimétricas (mm) / pulgadas (NPT).  
 Voltaje 50/60Hz.  
 We have milimetric (mm)/ inches (NPT). Volatge 50hz/60Hz.

- Bomba comercial robusta auto-aspirante con cuerpo anticorrosivo de plástico con base de plástico para piscina comercial de gran potencia.
- Trifásicas 50-60Hz. Disponible de 4.0 a 25.0CV a 2.850 rpm. Bridas estándar. DN 150 adaptable ANSI.
- Motor de alta eficiencia y ahorro energético.
- Para todo tipo de aguas grises, residuales e incluso para líquidos con ácidos.

- Self-priming robust commercial pump Body is made of corrosion residential plastic with integrated plastic mounting base plate.
- Triphasic 50-60Hz. Available from 4.0Hp to 25.0Hp at 2.850 rpm.
- Equipped with high-efficiency motor, energy saving and long service life.
- It is suitable for all kinds of waste water, sewage treatment and various acid-base liquid transportation.

## NDE-ZP 4.0 - 25.0 HP

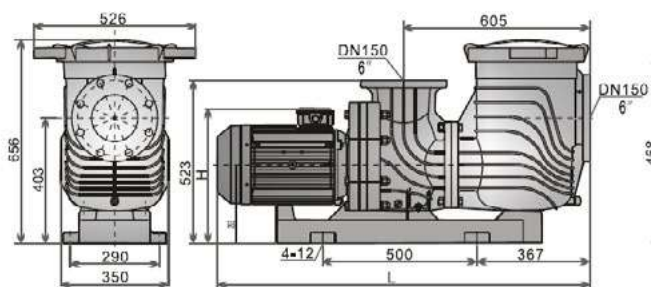
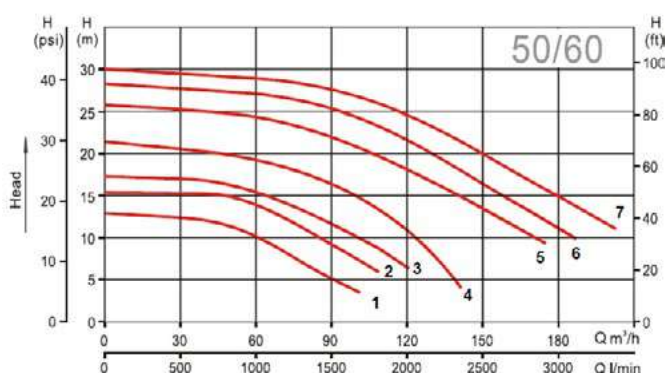

CÓDIGO	Curva	Power (hp)	Potencia (Kw)	Voltaje (v) frecuencia (Hz)	Qmax. (l/min)	Hmax (m)	Inlet / outlet	L (mm)	H (mm)
NDE-ZP0400T	1	4.0	3.0	380/3/50/60Hz	1.630	13,0	DN150 (6")	1155	414
NDE-ZP0500T	2	5.0	4.0	380/3/50/60Hz	1.780	15,5	DN150 (6")	1155	414
NDE-ZP0750T	3	7.5	5.5	380/3/50/60Hz	2.000	17,5	DN150 (6")	1155	414
NDE-ZP1000T	4	10.0	7.5	380/3/50/60Hz	2.300	21,5	DN150 (6")	1155	414
NDE-ZP1500T	5	15.0	11.0	380/3/50/60Hz	2.800	26,0	DN150 (6")	1210	433
NDE-ZP2000T	6	20.0	15.0	380/3/50/60Hz	3.000	28,0	DN150 (6")	1251	433
NDE-ZP2500T	7	25.0	18.5	380/3/50/60Hz	3.300	29,5	DN150 (6")	1251	433

# BOMBAS COMERCIALES COMMERCIAL PUMPS

## ZEUS BMZ 3.0 - 7.5 Hp

- Bomba auto-aspirante robusta para piscina comercial con bridas de conexión.
  - Monofásicas y Trifásicas 50-60Hz. Disponible de 3.0 a 15.0CV a 2.850 rpm.
  - Nueva generación de bombas residenciales comerciales de gran caudal, alto rendimiento.
  - Eje en acero inoxidable AISI 316.
  - El motor suministrado con IP55 y aislamiento clase F.
  - Muy Silenciosa. Tapa transparente.
  - Opcional “conexión absorción choque”.
  - Hidraulica&motor pueden separarse fácilmente.
- *Self-priming robust commercial pump. Ideal for aquariums, sea water, commercial pools, etc.*
  - *Monophasic and Triphasic 50-60Hz. Available from 3.0Hp to 15.0Hp at 2.850 rpm.*



CE

Disponemos conexiones milimétricas (mm) / pulgadas (NPT). Voltaje 50/60Hz.

We have milimetric (mm)/ inches (NPT). Volatge 50hz/60Hz.

- *A new generation of high flow, high head and energy efficiency residential and commercial pumps.*
- *Shaft in Stainless steel AISI 316.*
- *The Motor supplied comes with an IP55 and insultation F protection rating.*
- *Super quiet. Transparent lid.*
- *Optional shock absorber.*
- *Wet-end&motor can be easily detached on site.*

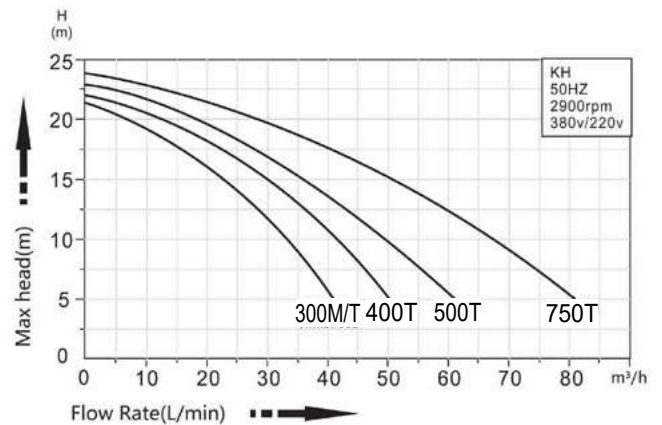
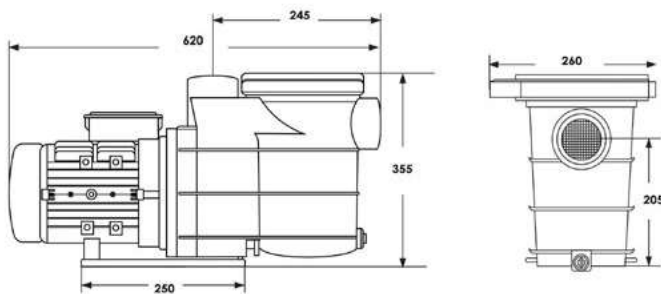

CODE	Power (hp)	Voltage (V)	Phases	Inlet Connection	Outlet Connection
BMZ300T	3.0	380-400	3	75 mm	65 mm
BMZ300M	3.0	220-240	1	75 mm	65 mm
BMZ400T	4.0	380-400	3	75 mm	65 mm
BMZ500T	5.0	380-400	3	75 mm	65 mm
BMZ750T	7.5	380-400	3	75 mm	65 mm

# BOMBAS COMERCIALES COMMERCIAL PUMPS

## ZEUS PLUS BMZP 7.5 - 15.0 Hp

- Bomba auto-aspirante robusta para piscina comercial con bridas de conexión.
  - Monofásicas y Trifásicas 50-60Hz. Disponible de 3.0 a 15.0CV a 2.850 rpm.
  - Bombas de alto rendimiento especiales para acuarios, agua de mar, etc.
  - Eje en acero inoxidable AISI 316.
  - El motor suministrado con IP55 y aislamiento clase F.
  - Muy Silenciosa. Tapa transparente.
  - Conexión 3" o 90mm.
- *Self-priming robust commercial pump. Ideal for aquariums, sea water, commercial pools, etc.*
- *Monophasic and Triphasic 50-60Hz. Available from 3.0Hp to 15.0Hp at 2.850 rpm.*



CE

Disponemos conexiones milimétricas (mm) / pulgadas (NPT). Voltaje 50/60Hz.

*We have milimetric (mm)/ inches (NPT). Volatge 50hz/60Hz.*

- *High performance pumps for aquariums, sea water, etc.*
- *Shaft in Stainless steel AISI 316.*
- *The Motor supplied comes with an IP55 and insultation F protection rating.*
- *Super quiet. Transparent lid.*
- *Union connection either 3" or 90mm.*

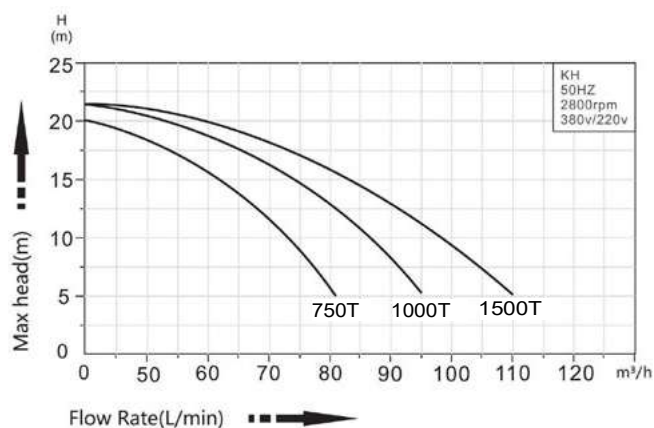
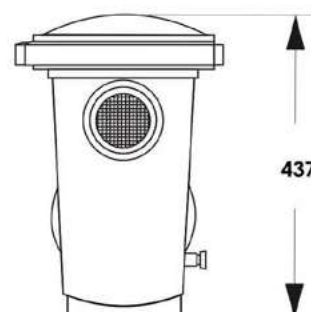
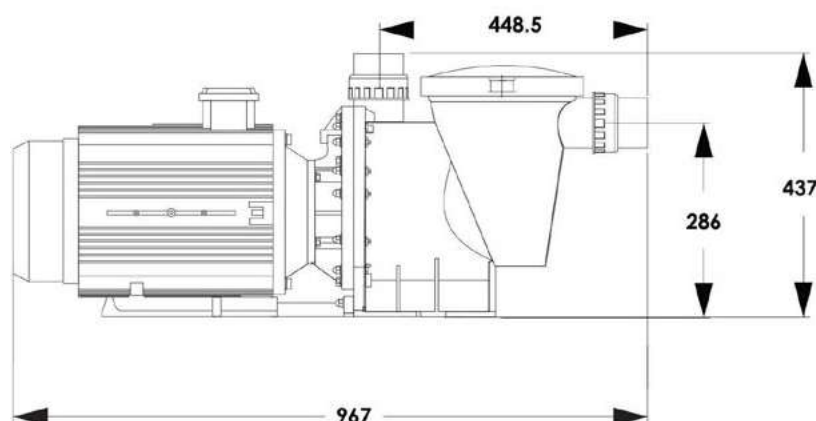

CODE	Power (hp)	Voltage (V)	Phases	Union Connection
BMZP0750T	7.5	380-400	3	3"
BMZP1000T	10.0	380-400	3	3"
BMZP1500T	15.0	380-400	3	3"

# BOMBA SUMERGIBLE SP025

## SUBMERSIBLE PUMP

- Interruptor de flotador magnético incorporado, especialmente adecuado para bombeo y drenaje en espacios con flechas.
- Conectado a la red eléctrica, sin necesidad de supervisión, arranque y parada automáticos.

**PRINCIPALES CARACTERÍSTICAS:**

- Más con 7 metros de cuerda para colocar la bomba de agua en la posición adecuada.
- Puede incluso aspirar niveles muy bajos de agua, con una salida lateral de 1,9 cm.
- Diseño de asa para facilitar su transporte.
- Nivel de protección IP68



CE

- *Built-in reliable magnetic float switch, especially suitable for pumping and drainage in arrow spaces.*
- *Connected to the power supply, no need for supervisión, automatic start and stop*

**MAIN FEATURES:**

- *With 10 meters of tow rope to position the water pump*
- *Low wáter levels can can also be sucked in, 1,9cm side outlet*
- *Handle design for easy carrying*
- *IP68 protection level*

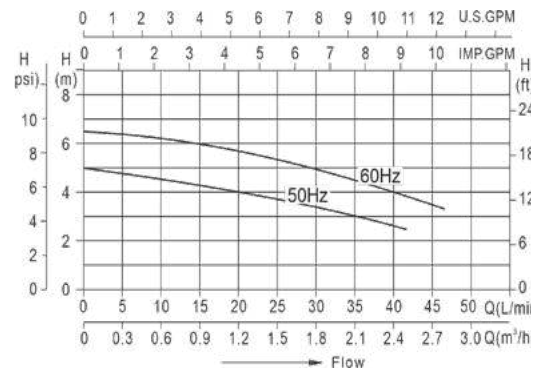
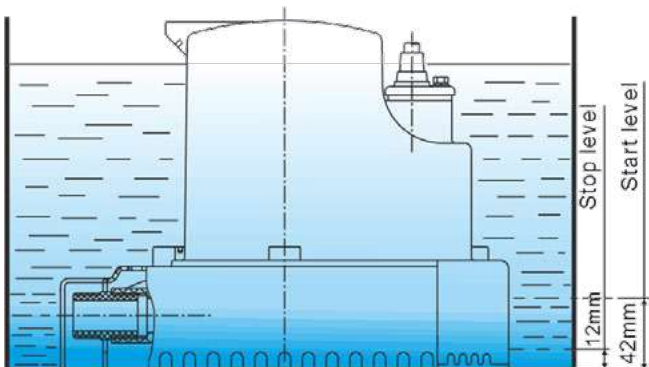

CODE	Power (hp)	Voltage (V)	INTENSITY A	MAX. FLOW (m³/h)	MAX. HIGH (m)	PACKAGING LxWxH (mm)
NDE-SP02560	1/4	110-120/60Hz	2,5	2,8	6,5	295x290x270
NDE-SP02550	1/4	220-240/50hZ	1,2	2,5	5	295x290x270

# SOPLANTE CONTINUO PVC



- Diseño compacto, silencioso y de apariencia moderna.
- No necesita aceite para lubricar para producir un aire más puro.
- Alto rendimiento con un consumo muy bajo.

- *Compact design, quiet with modern appearance.*
- *Non-oil lubricating design to produce more purified air.*
- *High performance with low power consumption.*

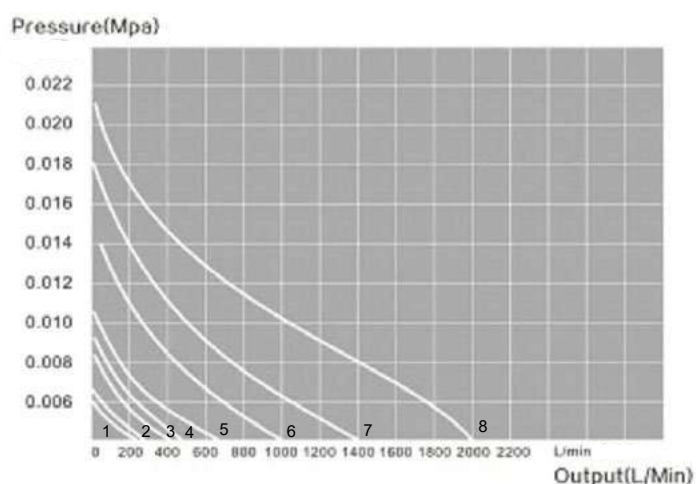

CODE	CURVE	Power (W)	Voltage (V)	Frequency (Hz)	Pressure (Mpa)	Weight (kg)	Size (mm)
BMB70	1	70	220-240	50/60	>0,006	7	236x179x186
BMB90	2	90	220-240	50/60	>0,007	7.4	233x199x207
BMB120	3	120	220-240	50/60	>0,009	8	230x199x215
BMB180	4	180	220-240	50/60	>0,010	10.2	255x223x230
BMB250	5	250	220-240	50/60	>0,011	11	256x246x256
BMB400	6	400	220-240	50/60	>0,015	17	295x295x305
BMB600	7	600	220-240	50/60	>0,019	21	315x310x325
BMB220T	8	220	380-400	50	>0,020	46.5	330x315x450



# MATERIAL VASO Y EXTERIOR PISCINA POOL BASIN & EXTERIOR EQUIPMENT

# SKIMMERS HORMIGÓN CONCRETE SKIMMERS

## AMSH STANDARD

Skimmer rosca Ø Inter.1,5" - Ø ext2" (ABS) - 50 Unidades.

- Skimmers de tapa redonda de 15 lt y marco cuadrado.
- Fabricado con materiales ABS de alta calidad con aditivos resistentes a rayos UV.
- Suministrado con aleta y cesta de vertedero.
- Conexión solvente de Ø 63mm.
- Conexión de succión secundaria opcional de Ø50mm.
- Caudal alto 10 m<sup>3</sup>/h.



Skimmer threaded Ø Inter.1,5" - Ø ext2" (ABS) - 50 Units.

- Skimmers of 15 lt round lid and square frame.
- Made of top quality ABS materials with UV resistant additives.
- Supplied with weir flap & basket.
- Solvent connection of Ø63mm.
- Optional secondary suction connection of Ø50mm.
- High flow rate 10 m<sup>3</sup>/h.

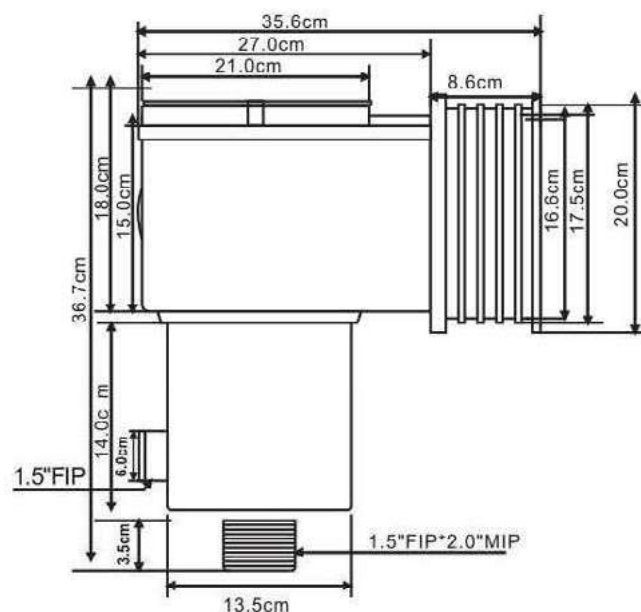
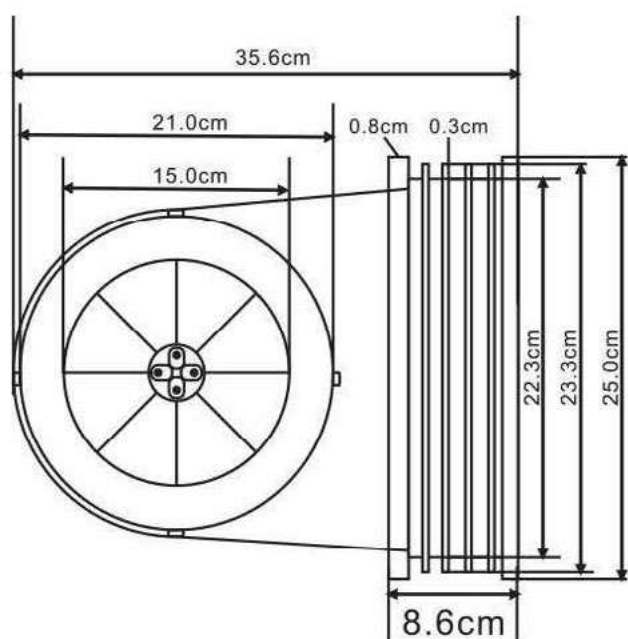
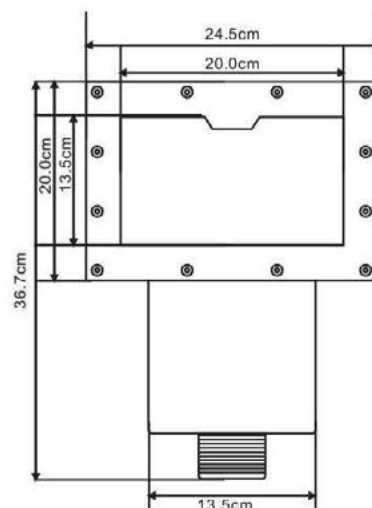

# SKIMMERS HORMIGÓN CONCRETE SKIMMERS

## AMSAH WIDE

Skimmer boca ancha encolar Ø Inter.1,5" - Ø ext2" (ABS) - 50 Unidades.

- Skimmers de tapa redonda de 15 lt y marco cuadrado.
- Fabricado con materiales ABS de alta calidad con aditivos resistentes a rayos UV.
- Suministrado con aleta y cesta de vertedero.
- Conexión solvente de Ø 63mm.
- Conexión de succión secundaria opcional de Ø50mm.
- Caudal alto 10 m³/h.

Wide Mouth Skimmer No threaded Ø Inter.1,5" - Ø ext2" (ABS) - 50 Units.

- Skimmers of 15 lt round lid and square frame.
- Made of top quality ABS materials with UV resistant additives.
- Supplied with weir flap & basket.
- Solvent connection of Ø63mm.
- Optional secondary suction connection of Ø50mm.
- High flow rate 10 m³/h.

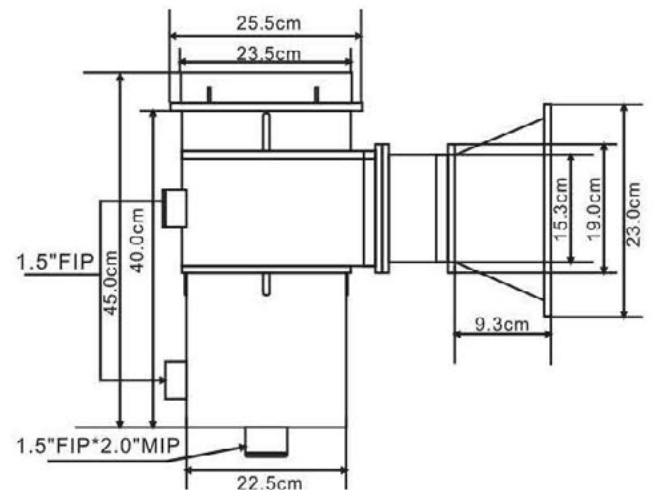
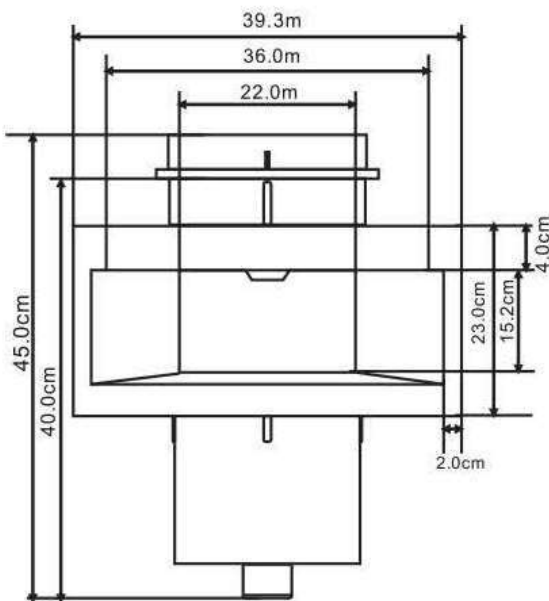
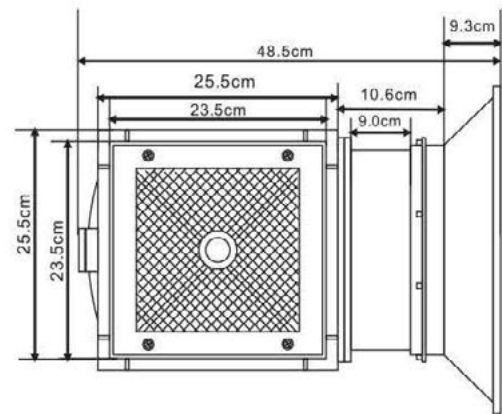

# BOQUILLAS HORMIGÓN CONCRETE INLETS



## AMIHRI3 & AMIHRM3

Boquilla impulsión. Roscar int./ext. (ABS)

*Eyeball Inlet. Threaded Int./ext. (ABS)*

CODE	Description	Ø	Units
AMIHRI3	Boquilla impulsión Imperial <i>Eyeball Inlet Imperial</i>	Int. 1,5" Ext. 2,0"	50
AMIHRM3	Boquilla impulsión Métrico <i>Eyeball Inlet Metric</i>	Int. 50mm Ext. 63mm	50

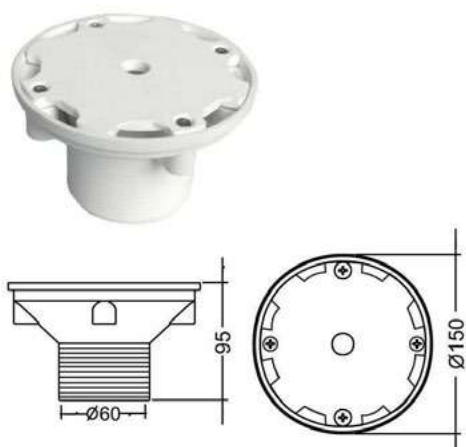

## AMIHRI4 & AMIHRM4

Boquilla impulsión. Roscar int./ext. (ABS)

*Eyeball Inlet. Threaded Int./ext. (ABS)*

CODE	Description	Ø	Units
AMIHRI4	Boquilla impulsión Imperial <i>Eyeball Inlet Imperial</i>	Int. 1,5" Ext. 2,0"	50
AMIHRM4	Boquilla impulsión Métrico <i>Eyeball Inlet Metric</i>	Int. 50mm Ext. 63mm	50



## AMIHEI5 & AMIHEM5

Boquilla impulsión. Encolar int./ext. (ABS)

*Eyeball Inlet. No threaded Int./ext. (ABS)*

CODE	Description	Ø	Units
AMIHEI5	Boquilla impulsión Imperial <i>Eyeball Inlet Imperial</i>	Int. 1,5" Ext. 2,0"	50
AMIHEM5	Boquilla impulsión Métrico <i>Eyeball Inlet Metric</i>	Int. 50mm Ext. 63mm	50

# BOQUILLAS HORMIGÓN CONCRETE INLETS

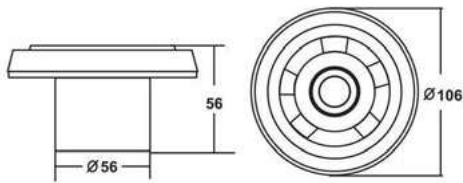

## AMIHEI6 & AMIHEM6

Boquilla impulsión. Encolar int./ext. (ABS)

*Eyeball Inlet. No threaded Int./ext. (ABS)*

CODE	Description	Ø	Units
AMIHEI6	Boquilla impulsión Imperial <i>Eyeball Inlet Imperial</i>	Int. 1,5" Ext. 2,0"	50
AMIHEM6	Boquilla impulsión Métrico <i>Eyeball Inlet Metric</i>	Int. 50mm Ext. 63mm	50

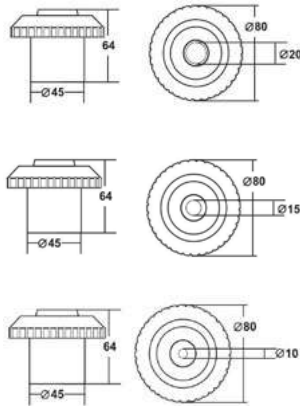

## AMIHEI & AMIHEM

Boquilla impulsión. Encolar int./ext. (ABS)

*Eyeball Inlet. No threaded Int./ext. (ABS)*

CODE	Description	Ø	Units
AMIHEI7	Imperial <i>Imperial</i>	Int. 1,5" - Ext. 2,0"	50
AMIHEM7	Métrico <i>Metric</i>	Int. 50mm - Ext. 63mm	50
AMIHEI8	Imperial <i>Imperial</i>	Int. 1,5" - Ext. 2,0"	50
AMIHEM8	Métrico <i>Metric</i>	Int. 50mm - Ext. 63mm	50
AMIHEI9	Imperial <i>Imperial</i>	Int. 1,5" - Ext. 2,0"	50
AMIHEM9	Métrico <i>Metric</i>	Int. 50mm - Ext. 63mm	50

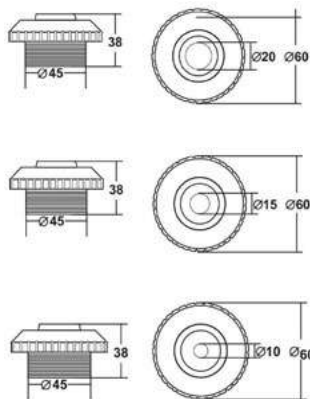

## AMIHRI & AMIHRM

Boquilla impulsión. Roscar int./ext. (ABS)

*Eyeball Inlet. Threaded Int./ext. (ABS)*

CODE	Description	Ø	Units
AMIHRI10	Imperial <i>Imperial</i>	Int. 1,5" - Ext. 2,0"	50
AMIHRM10	Métrico <i>Metric</i>	Int. 50mm - Ext. 63mm	50
AMIHRI11	Imperial <i>Imperial</i>	Int. 1,5" - Ext. 2,0"	50
AMIHRM11	Métrico <i>Metric</i>	Int. 50mm - Ext. 63mm	50
AMIHRI12	Imperial <i>Imperial</i>	Int. 1,5" - Ext. 2,0"	50
AMIHRM12	Métrico <i>Metric</i>	Int. 50mm - Ext. 63mm	50

# BOQUILLAS HORMIGÓN CONCRETE INLETS

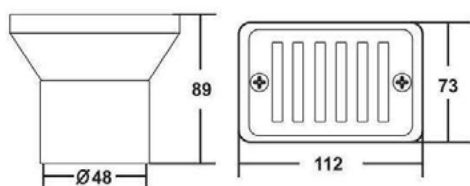

## AMFGH48 & AMFGH63

Boquilla fondo Gutter. Encolar (ABS)

*Gutter drain. No threaded (ABS)*

CODE	Description	Ø (mm)	Height (mm)	Units
AMFGH48	Boquilla fondo Gutter <i>Gutter drain</i>	48	89	50
AMFGH63	Boquilla fondo Gutte <i>Gutter drain</i>	63	99	50

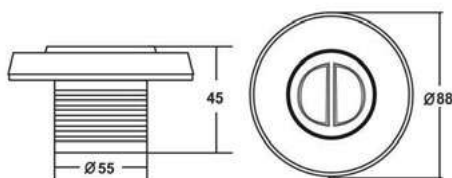

## AMAHRI & AMAHRM

Boquilla aspiración. Roscar int./ext. (ABS)

*Suction head. Threaded Int./ext. (ABS)*

CODE	Description	Ø	Units
AMAHRI	Boquilla aspiración Imperial <i>Suction head Imperial</i>	Int. 1,5" Ext. 2,0"	50
AMAHRM	Boquilla aspiración Métrico <i>Suction head Metric</i>	Int. 50mm Ext. 63mm	50

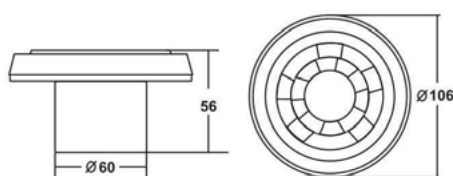

## AMAHEI & AMAHEM

Boquilla aspiración. Encolar int./ext. (ABS)

*Suction head. No threaded Int./ext. (ABS)*

CODE	Description	Ø	Units
AMAHEI	Boquilla aspiración Imperial <i>Suction head Imperial</i>	Int. 1,5" Ext. 2,0"	50
AMAHEM	Boquilla aspiración Métrico <i>Suction head Metric</i>	Int. 50mm Ext. 63mm	50

# BOQUILLAS HORMIGÓN CONCRETE INLETS

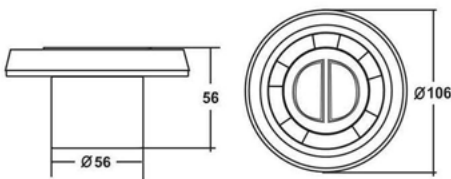

## AMAHEI2 & AMAHEM2

Boquilla aspiración. Encolar int./ext. (ABS)

*Suction head No threaded int./ext. (ABS)*

CODE	Description	Ø	Units
AMAHEI2	Boquilla aspiración Imperial <i>Suction head Imperial</i>	Int. 1,5" Ext. 2,0"	50
AMAHEM2	Boquilla aspiración Métrico <i>Suction head Metric</i>	Int. 50mm Ext. 63mm	50

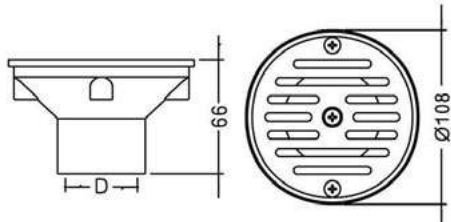

## AMAHEI3/AMAHEM3/AMAHRI3/AMAHRM3

Boquilla aspiración. Int./ext. (ABS)

*Suction head. Int./ext. (ABS)*

CODE	Description	Ø	Units
AMAHEI3	Encolar. Imperial <i>No threaded. Imperial</i>	Int. 1,5" Ext. 2,0"	50
AMAHEM3	Encolar. Métrico <i>No threaded. Metric</i>	Int. 50mm Ext. 63mm	50
AMAHRI3	Roscar. Imperial <i>Threaded. Imperial</i>	Int. 1,5" Ext. 2,0"	50
AMAHRM3	Roscar. Métrico <i>Threaded. Metric</i>	Int. 50mm Ext. 63mm	50

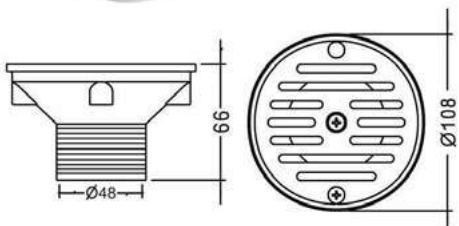

## AMIHRI2 & AMIHRM2

Boquilla impulsión. Roscar int./ext. (ABS)

*Eyeball Inlet. Threaded Int./ext. (ABS)*

CODE	Description	Ø	Units
AMIHRI2	Boquilla impulsión Imperial <i>Eyeball Inlet Imperial</i>	Int. 1,5" Ext. 2,0"	50
AMIHRM2	Boquilla impulsión Métrico <i>Eyeball Inlet Metric</i>	Int. 50mm Ext. 63mm	50

# SUMIDERO HORMIGÓN CONCRETE DRAIN

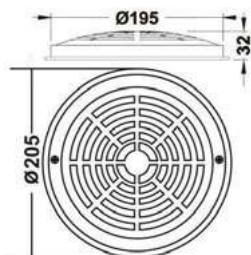

## AMSTRH195

Tapa redonda sumidero (ABS)

*Round main drain cover (ABS)*

CODE	Description	Ø	Units
AMSTRH195	Tapa redonda sumidero <i>Round main drain cover</i>	195 mm	50

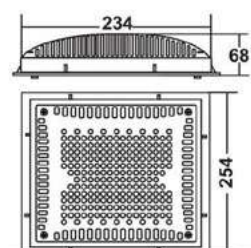

## AMSTCH234V

Tapa cuadrada sumidero Anti Vórtex (ABS)

*Square main drain cover Anti Vortex (ABS)*

CODE	Description	Dimensions	Units
AMSTCH234V	Tapa cuadrada sumidero <i>Square main drain cover</i>	234x254 mm	50

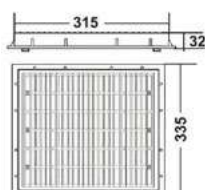

## AMSTCH234 & AMSTCH315

Tapa cuadrada sumidero (ABS)

*Square main drain cover (ABS)*

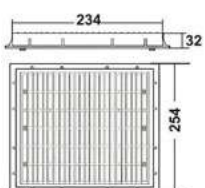

CODE	Description	Dimensions	Units
AMSTCH234	Tapa cuadrada sumidero <i>Square main drain cover</i>	234x254 mm	50
AMSTCH315	Tapa cuadrada sumidero <i>Square main drain cover</i>	315x335 mm	50



# MATERIAL VASO PISCINA PARA LINER

## POOL BASIN LINER WHITE GOODS

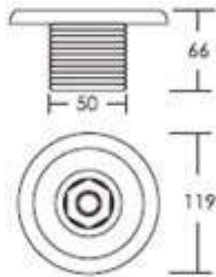

### AMILRM

Boquilla Impulsión "Multiflow" para liner. Roscar int./ext. (ABS)

*Threaded "Multiflow" wall inlet for liner. Int./ext. (ABS)*

CODE	Description	Ø (mm)	Height (mm)	Units
AMILRM	Boquilla Impulsión "Multiflow" para liner. Roscar ext.2" <i>Threaded "Multiflow" wall inlet for liner ext.2"</i>	Int. 50	66	200

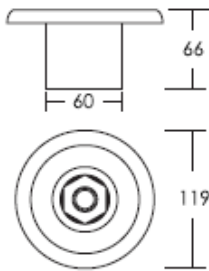

### AMILEM

Boquilla Impulsión "Multiflow" para liner. Encolar int./ext. (ABS)

*No threaded "Multiflow" wall inlet for liner. Int./ext. (ABS)*

CODE	Description	Ø (mm)	Height (mm)	Units
AMILEM	Boquilla Impulsión "Multiflow" para liner. Encolar ext.60m <i>Non Threaded "Multiflow" wall inlet for liner ext.60mm</i>	Int. 50	66	200

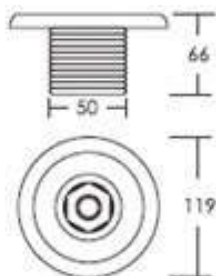

### AMALRM

Boquilla Aspiración "Multiflow" para liner. Roscar int./ext. (ABS)

*Threaded "Multiflow" suction inlet for liner. Int./ext. (ABS)*

CODE	Description	Ø (mm)	Height (mm)	Units
AMALRM	Boquilla Aspiración "Multiflow" para liner. Roscar ext.2" <i>Threaded "Multiflow" suction inlet for liner ext.2"</i>	Int. 50	66	200

# MATERIAL VASO PISCINA PARA LINER

## POOL BASIN LINER WHITE GOODS

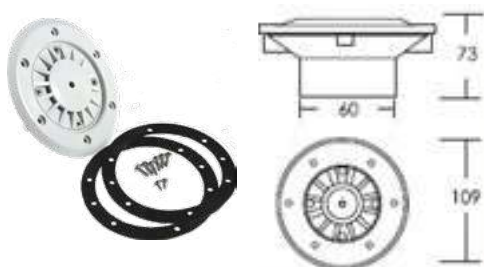

### AMBLEM

Boquilla suelo para liner. Encolar int./ext. (ABS)

*Bottom inlet for liner. No threaded Int./ext. (ABS)*

CODE	Description	Ø (mm)	Height (mm)	Units
AMBLEM	Boquilla suelo para liner. Encolar ext.2" <i>Bottom inlet for liner ext.2"</i>	Int. 50	73	200



### AMWCE

Pasamuros para liner. Encolar int./ext. (ABS)

*Wal conduit. Non-threaded for liner. Int./ext. (ABS)*

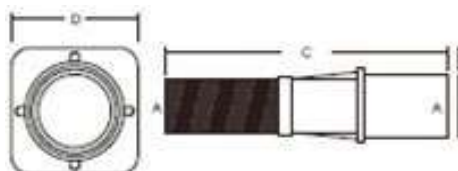

CODE	Description	Ø (mm)	Height (mm)	Units
AMWCE	Pasamuros para liner. Encolar ext.2" <i>Wall conduit Non-threaded for liner ext.2"</i>	Int. 50 (Gris ABS)	A:50mm B:2" C:300mm D:80mm	200



### AMWCR

Pasamuros para liner. Roscar int./ext. (ABS)

*Wal conduit threaded for liner. Int./ext. (ABS)*

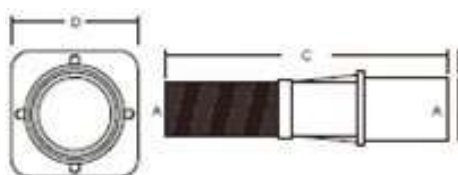

CODE	Description	Ø (mm)	Height (mm)	Units
AMWCR	Pasamuros para liner. Roscar ext.2" <i>Wall conduit threaded for liner ext.2"</i>	Int. 50 (Gris ABS)	A:50mm B:2" C:300mm D:80mm	200

# REJILLAS GRATINGS

Rejilla rebosadero Resistence UV (ABS). Colores Blanco / Amarillo / Verde / Azul / Rojo.

*Overflow grating UV Resistance (ABS). Colors White / Yellow / Green / Blue / Red.*

- CODE: AMR150
- CODE: AMR178
- CODE: AMR200
- CODE: AMR235
- CODE: AMR240
- CODE: AMR300
- CODE: AMR310

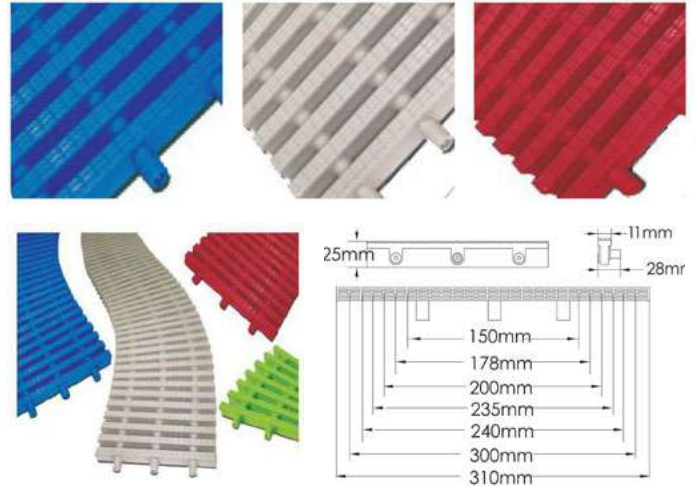

Rejilla rebosadero Resistence UV (ABS). 40 piezas/m. Reforzado con Aluminio. Colores Blanco / Azul / Gris / Verde / Verde oscuro / Naranja.

*Overflow grating UV Resistance (ABS). 40 pieces/m. Supported with aluminium. Colors White / Blue / Grey / Green / Dark green / Orange.*

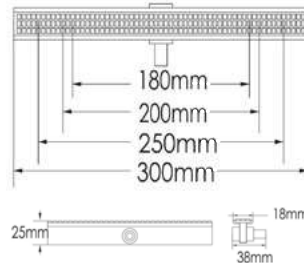

- CODE: AMRP180
- CODE: AMRP200
- CODE: AMRP250
- CODE: AMRP235
- CODE: AMRP300

Rejilla rebosadero Resistence UV (ABS). Reforzado con Aluminio. Colores Blanco / Amarillo / Azul / Verde / Rojo.

*Overflow grating UV Resistance (ABS). Supported with aluminium. Colors White / Yellow / Blue / Green / Red.*

- CODE: AMRP3030

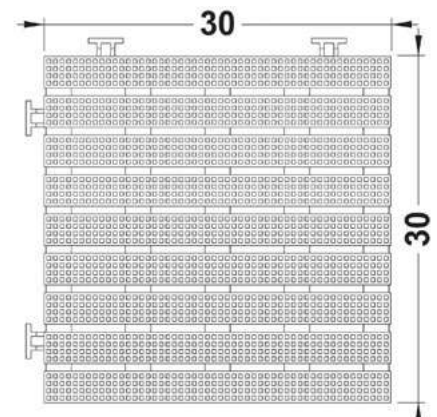

# CONTRACORRIENTE WMCC

## WMCC JET TRAINER

- Contracorriente con frontal de ABS LED incluido (RGB o Blanco).
- Control de efecto de las burbujas y del caudal.
- Para instalar en la pared de piscinas con botón de encendido/apagado en el frontal.
- Opcional: Bomba centrífuga con cojinetes resistentes a altas temperaturas, IP55 y protección clase F.
- *Counter current head with LED light (RGB or white).*
- *Adjustable valve to control bubble effect and water flow.*
- *On/off switch on the head for easy switching underwater.*
- *Optional: Centrifugal pump with high temperature bearings, enclosure class IP55 and insulation class F.*

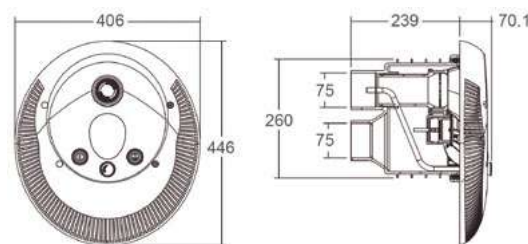

### ACCESORIOS ACCESSORIES



Caja Contracorriente (opcional)  
*Jet box (220V/380V) (optional)*



Bomba centrífuga (opcional)  
*Centrifugal pump (opcional)*

CODE	Desription	Power (hp)	Voltage (V)	Pump connection (mm)	Water capacity (m³/h)	Hmax (m)
WMCHRGB	Counter Current Head LED Light RGB	-	-	-	-	-
WMCB1	Control Box	-	220	-	-	-
WMCB2	Control Box	-	380	-	-	-
WMCK	Piping Kit for Pump	-	-	-	-	-
BME400	Pump	4	380	75	78	13
BME600	Pump	6	380	75	90	17,5

# CASCADA LED WATERFALL LED

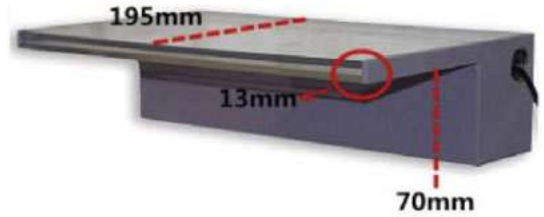

- Cascada acrílica empotrable con luz LED de varios tamaños. Opcional control remoto.
- Disponible en Blanco/Azul o Multicolor (8 colores).

## CÓMO ESCOGER TU CASCADA LED

1. Seleccione el modelo.
2. Conexión por debajo o por atrás.
3. Conexión roscada de 1" o 1,5".
4. Con o sin LED.
5. Con LED: con o sin Control Remoto.
6. Con LED y sin Control Remoto: LED Blanco Caliente o Blanco/Azul.

- Waterfall curtain LED light. Different sizes and remote control optional.
- Supplied with White/Blue or Multicolor (8 colors).

## HOW TO CHOOSE YOUR LED WATERFALL

1. Select Model.
2. Bottom or back inlet connection.
3. Inlet threaded connection size 1" or 1,5".
4. With or without LED.
5. With LED: with or without Remote Control.
6. Con LED and Without Remoto Control: Select White Warm or White/Blue.

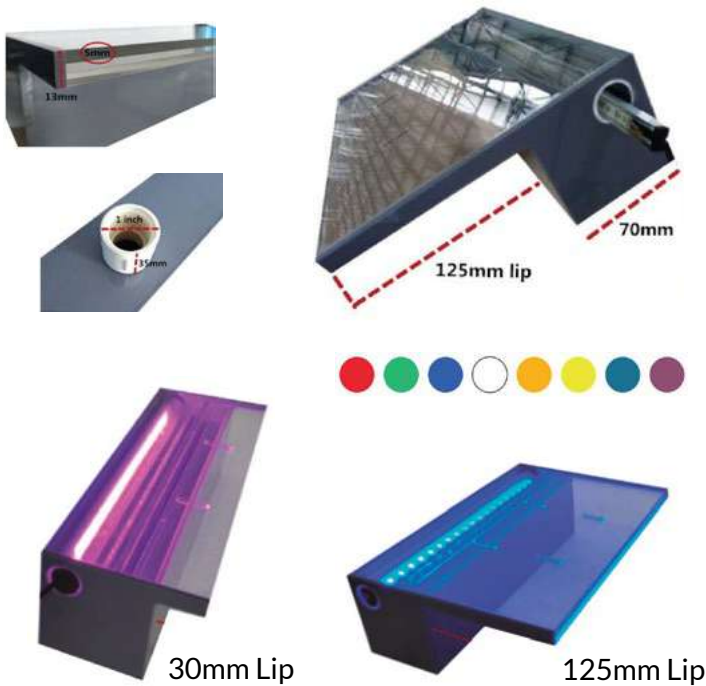

CODE	Width (mm)	Depth of Lip (mm)	Recommended flow at 120 cm height (l/h)	Entry	Connection Size (inch)	Carton Qty (pcs/ctn)
WMW3	300	30	4000	Bottom or Back	1" or 1,5"	4,00
WMW6	600	30	6000			
WMW9	900	30	9000			
WMW12	1200	30	12000			
WMW3L	300	125	4000			
WMW6L	600	125	6000			
WMW9L	900	125	9000			
WMW12L	1200	125	12000			

\*Con Control Remoto añadir al código R. With Remote Control add to the code R.

# ESCALERAS LADDERS

Peldaño antideslizante incluido  
Anti-slip step included

## ARCO OVERFLOW

AISI 304L

AISI 316L

Steps	Code	Code	a. mm
2	-	WF87111720N	696
3	WF87110870N	WF87111738N	946
4	WF87110888N	WF87111746N	1196
5	-	WF87111753N	1446



## ESTÁNDAR RESIDENCIAL

AISI 304L

AISI 316L

Steps	Code	Code	a. mm
2	WF87112926N	WF87111928N	696
3	WF87112934N	WF87111936N	946
4	WF87112942N	WF87111944N	1196
5	WF87112959N	WF87111951N	1446



## MIXTA PARELLEL-LOCK

AISI 304L

AISI 316L

Steps	Code	Code	a. mm
2	WF87120861N	-	696
3	WF87120879N	WF87121877N	946
4	WF87120887N	WF87121885N	1196
5	WF87120895N	WF87121893N	1446



# ESCALERAS LADDERS

Peldaño antideslizante incluido  
Anti-slip step included

## MURO WALL

AISI 304L

AISI 316L

Steps	Code	Code	a. mm
2	WF87132023N	WF87131124N	696
3	WF87132031N	WF87131132N	946
4	WF87132049N	WF87131140N	1196
5	WF87132056N	WF87131157N	1446

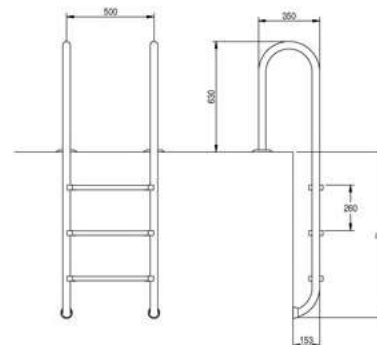

## MURO ASIMÉTRICO ASYMMETRIC WALL

AISI 304L

Steps	Code	a. mm
2	WF87133021N	698
3	WF87133039N	948

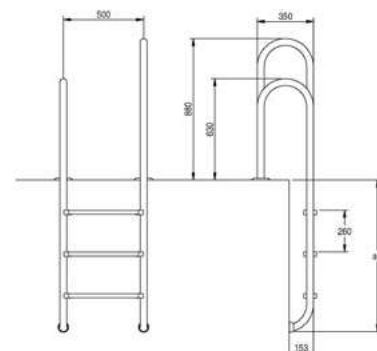

## PUENTE ABOVE GROUND

AISI 304L

Steps	Code	a.	b.	c.
3/3	WF87140034N	1155	1670	1065
4/4	WF87140042N	1350	1900	1370
5/5	WF87140059N	1545	2130	1525

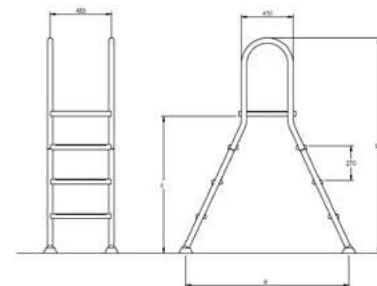

# ESCALERAS LADDERS

Peldaño antideslizante incluido  
Anti-slip step included

## PUENTE SEMIELEVADA SEMI-ELEVATED ABOVE GROUND

AISI 304L

Steps	Code	a. mm	b. mm	c. mm
1/4	WF87143418N	1900	1370	690
1/5	WF87143517N	2130	1525	920

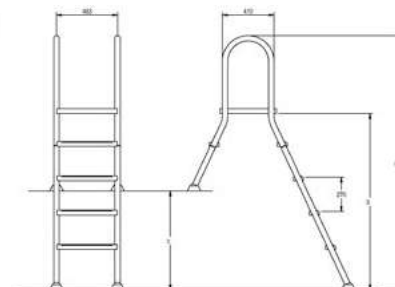

## PUENTE ABOVE GROUND

## PUENTE SEMIELEVADA SEMI-ELEVATED ABOVE GROUND

Code	Descripción / Description
WF87100137	Peldaño <i>Step</i>
WF87100889	Tapón tope articulado <i>Articulated rubber bumper</i>
WF87100194	Plataforma <i>Platform</i>

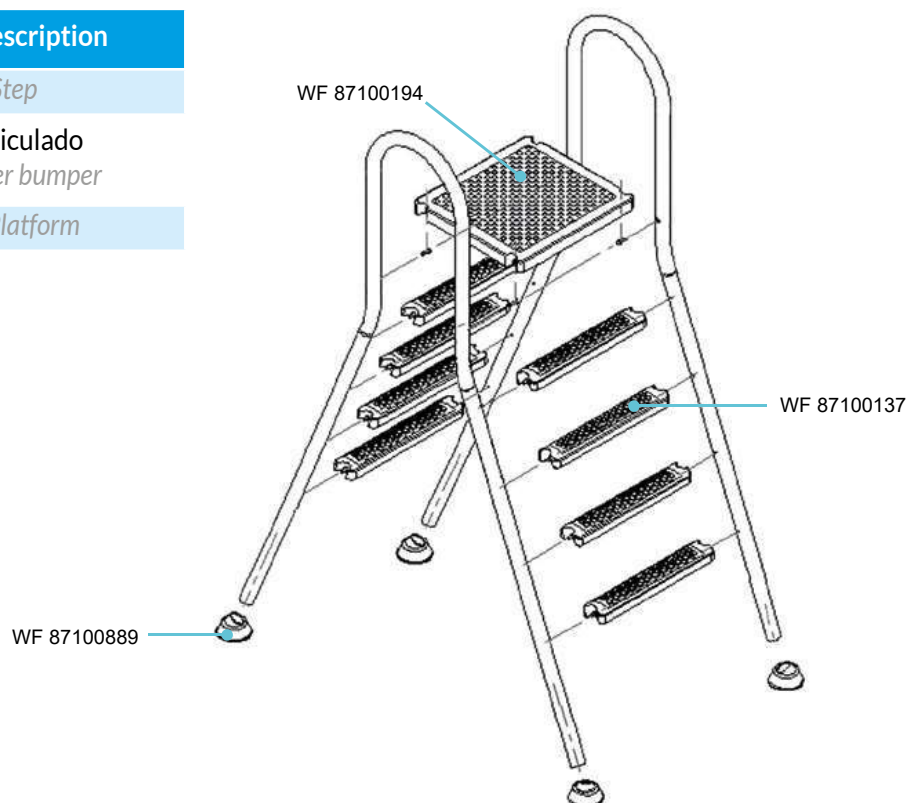



# ESCALERAS LADDERS

Peldaño antideslizante incluido  
Anti-slip step included

ARCO OVERFLOW  
ARCO ESPECIAL SPECIAL OVERFLOW  
ESTÁNDAR RESIDENTIAL  
MIXTA PARALLEL-LOC  
MURO WALL  
MURO ASIMÉTRICA ASYMMETRIC WALL

Code	Descripción / Description	
WF87100251	Tornillo para peldaños (x 10 u.) <i>Screws for treads (x 10 u.)</i>	AISI 304
WF87100252	Tornillo para peldaños (x 10 u.) <i>Screws for treads (x 10 u.)</i>	AISI 316
WF87100160	Peldaño antideslizante <i>Non-slip tread</i>	AISI 304L
WF87100897	Peldaño antideslizante <i>Non-slip tread</i>	AISI 316L
WF87100236	Tapón <i>Rubber bumper</i>	
WF87100095	Embellecedor <i>Escutcheon</i>	AISI 304
WF87100103	Embellecedor <i>Escutcheon</i>	AISI 316L
WF87100335	Anclaje <i>Anchorage socket</i>	AISI 316L

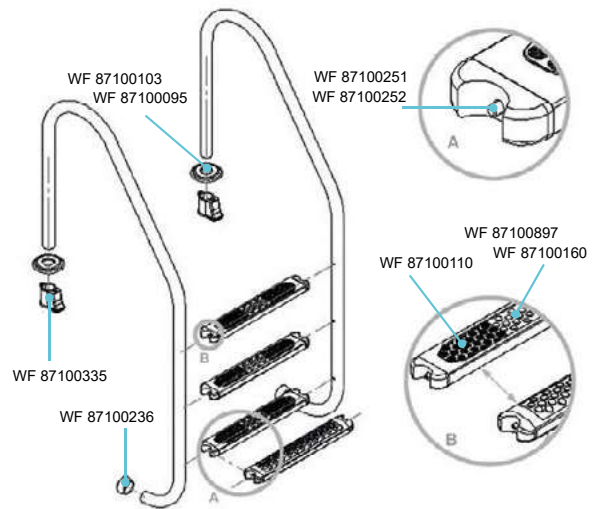

## AEROSOL PROTECTOR PROTECTIVE SPRAY

Code	Descripción / Description
WF05000034	Protección a largo plazo (hasta 2 años al aire libre) para todos el acero inoxidable. Sellado de cera a prueba de humedad. Muy resistente a la humedad y niebla salina. <i>Long-term protection (up to 2 years outdoors) for stainless steel. Waxy film seals out moisture effectively. Highly resistant to humidity and salt spray.</i>



## ANCLAJE ANCHORAGE SOCKET

Code	Kg	u.
WF87100335	0.280	x2

Incluye toma de tierra.  
*Earthing cable included.*

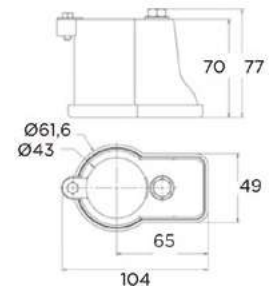

# ESCALERAS LADDERS

## ANCLAJE ARTICULADO ARTICULATED ANCHORAGE

AISI 304L

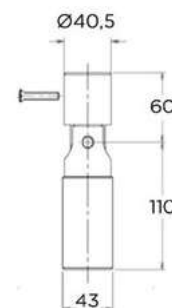

Code	Kg	u.
WF87100981	3,0	x2

## ANCLAJE ARTICULADO DESMONTABLE ARTICULATED ANCHORAGE WITH FLANGE

AISI 304L

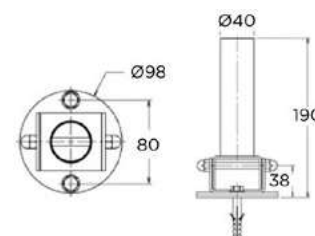

Code	Kg	u.
WF87100980	1,700	x2

## ANCLAJE DESMONTABLE ANCHORAGE WITH FLANGE

AISI 304L

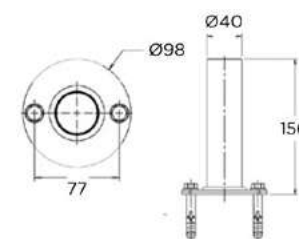

Code	Kg	u.
WF87100061	0.815	x2

## EMBELLECEDOR ESCUTCHEON

Code	Kg	AISI	u.
WF87100095	65.000	304L	x2
WF87100103	65.000	316L	x2

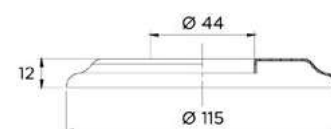

## KIT PARA LINER KIT FOR LINER

Code	Kg	u.
WF87100021	1,00	x2

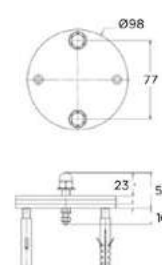

## ESCALERAS LADDERS

PELDAÑO PLÁSTICO (ABS) PARA ESCALERA ELEVADA  
 PLASTIC (ABS) TREAD FOR ABOVE GROUND LADDER



Code	Kg	u.
WF87100137	-	x1

No incluye tornillos. *Screws not included.*

TAPA ANCLAJE ESCALERA COVER FOR ANCHORAGE

AISI 304L

Code	Kg	u.
WF87100948	0.0280	x2

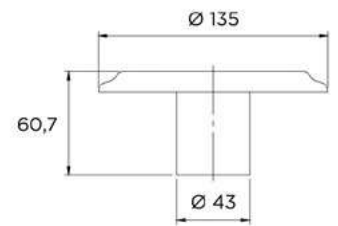

PLATAFORMA PLATFORM

Code
WF87100194



TAPÓN RUBBER BUMPER

Code	Kg	u.
WF87100236	0,05	x2



TAPÓN TOPE ARTICULADO ARTICULATED RUBBER BUMPER

Code	Kg	u.
WF87100889	0,18	x2



TORNILLERIA PARA PELDAÑOS SCREWS FOR TREADS

Code	Kg	AISI	M	u.
WF87100251	0,01	304	M8	x 10
WF87100252	0,01	316	M8	x 10



A-316L Electropulido. *A-316L electropolished.*

# ESCALERAS ELECTROPULIDAS ELECTROPOLISHED LADDERS

Peldaño antideslizante incluido  
Anti-slip step included

## ESTÁNDAR RESIDENTIAL

AISI 316L

Steps	Code	a. mm
3	WF87111940N	946
4	WF87111950N	1196

Electropulido. *Electropolished.*

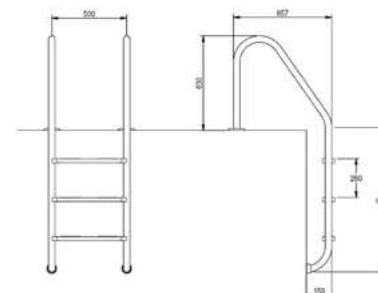

## MIXTA PARALLEL-LOCK

AISI 316L

Steps	Code	a. mm
3	WF87120880N	946
4	WF87120890N	1196

Electropulido. *Electropolished.*

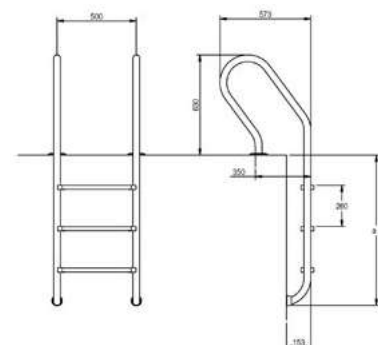

## MURO WALL

AISI 316L

Steps	Code	a. mm
3	WF87131141N	946
4	WF87131151N	1196

Electropulido. *Electropolished.*

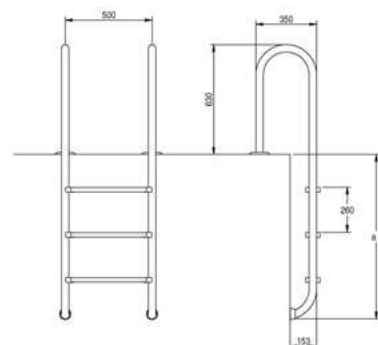

# ESCALERAS PARTIDA DOS PIEZAS TWO PIECES LADDERS

Peldaño antideslizante incluido  
Anti-slip step included

## JUEGO PASAMANO PARTIDA TWO PIECES HANDRAILS SET

AISI 316L

Code	Electropulido. <i>Electropolished.</i>
WF87101317N	

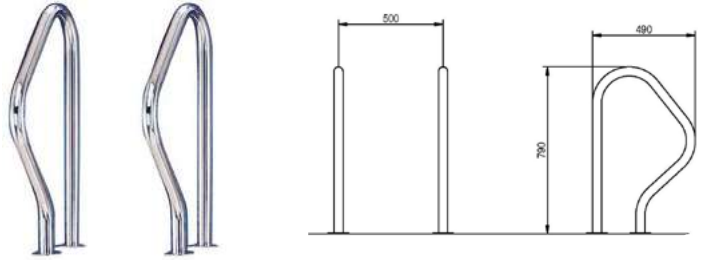

### PARTE INFERIOR LOWER PART

AISI 316L

Steps	Code	a.
2	WF87174322N	515
3	WF87174330N	765
4	WF87174348N	1015
5	WF87174355N	1265



Electropulido. *Electropolished.*

Seleccionar 2 códigos: Juego pasamano + parte inferior.  
*Select 2 codes: Two pieces handrails set + lower part.*

## PELDAÑO ANTIDESLIZANTE NON-SLIP TREAD

Code	Kg	AISI	u.
WF87100160	0,062	304L	x1
WF87100897	0,062	316L	x1
WF87100896	0,062	316L	x1



Electropulido *Electropolished.*

No incluye tornillos. *Screws not included.*

## PELDAÑO DOBLE DE SEGURIDAD DOUBLE SAFETY STEP

Type	Code	Kg	AISI	u.
Recto Right	WF87101603	1.65	316L	x10
Inclinado Inclined	WF87101604 *	1.65	316L	x10



\* Para fácil acceso y partida fácil acceso.  
*For easy access and two pieces easy access.*  
Incluye tornillos. *Screws included.*  
Electropulido. *Electropolished.*

# ESCALERAS PÚBLICAS PUBLIC LADDERS

Peldaño antideslizante incluido  
Anti-slip step included

## ARCO ESPECIAL SPECIAL OVERFLOW

AISI 316L

Steps	Code	a. mm
3	WF87111763N	946
4	WF87111764N	1196
5	WF87111765N	1446

Peldaño de seguridad. *Double safety step.*

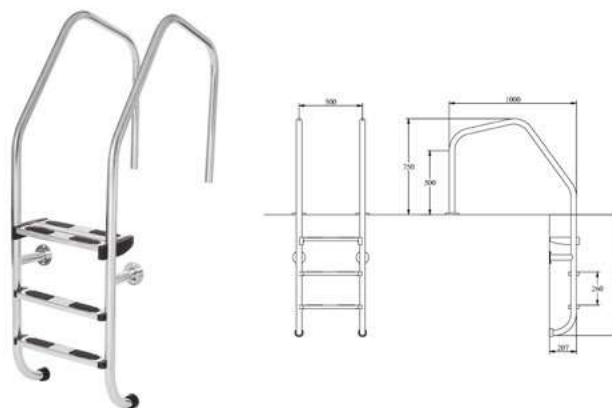

## FÁCIL ACCESO EASY ACCESS

AISI 316L

Steps	Code	a. mm	b. mm
3	WF87252010N	1005	511
4	WF87252011N	1225	630

Peldaño de seguridad. *Double safety step.*  
Electropulido. *Electropolished.*

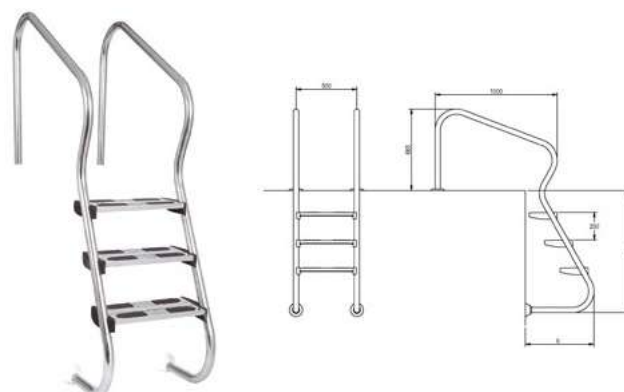

## FÁCIL ACCESO EASY ACCESS

Code	Descripción / Description	
WF87101604	Peldaño de seguridad 43° <i>Safety double tread 43°</i>	AISI 316L
WF87100889	Tapón tope articulado <i>Articulater rubber bumper</i>	
WF87100103	Embellecedor <i>Escutcheon</i>	AISI 316L
WF87100335	Anclaje <i>Anchorage socket</i>	

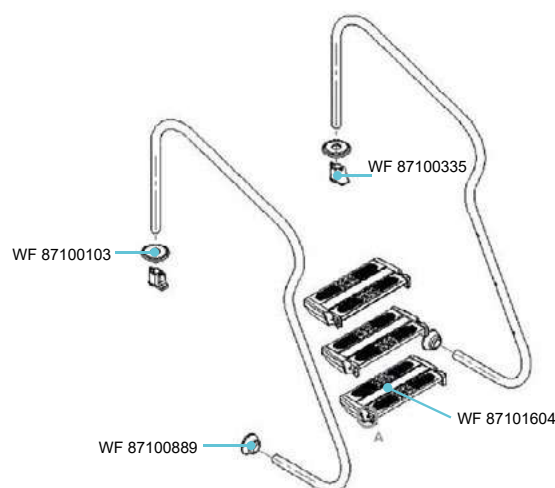

# ESCALERAS PÚBLICAS PUBLIC LADDERS

Peldaño antideslizante incluido  
Anti-slip step included

## PARTIDA FÁCIL ACCESO TWO PIECES EASY ACCESS

AISI 316L

Steps	Code	a.
3	WF87161021N	865
4	WF87161022N	1085

Peldaño de seguridad.  
Double safety step.

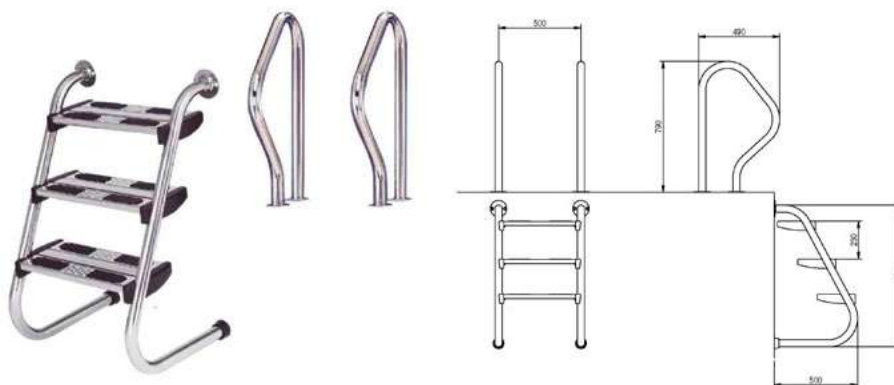

## ESCALERA LAND 500 FÁCIL ACCESO EASY ACCESS LAND 500

Peldaño de plástico antideslizante de ancho especial 457x325 mm. Posibilidad de adaptación a diferentes profundidades. Recomendada para personas con movilidad reducida.

Non-slip plastic tread with special dimensions 457x325 mm. Possibility to adapt to different depths. Recommended ladder for disabled people/elderly people.

AISI 316L

Steps	Code	a.	b.
5	WF87152035N	1180-1380	1600
6	WF87152036N	1390-1590	1850
7	WF87152037N	1600-1800	2100

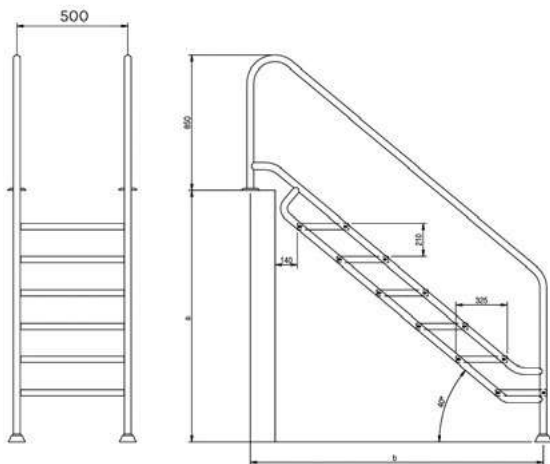

# ESCALERAS LADDERS

Peldaño antideslizante incluido  
Anti-slip tread included

## ESCALERA LAND 700 FÁCIL ACCESO EASY ACCESS LAND 700

Peldaño antideslizante de ancho especial 657x350 mm. Posibilidad de adaptación a diferentes profundidades. Recomendada para personas con movilidad reducida.

Anti-slip step with special dimensions 657x350 mm. Possibility to adapt to different depths. Recommended ladder for disabled people/elderly people.

Steps	Code	a. mm	b. mm
5	WF87152020	1180-1380	1600
6	WF87152021	1390-1590	1850
7	WF87152022	1600-1800	2100

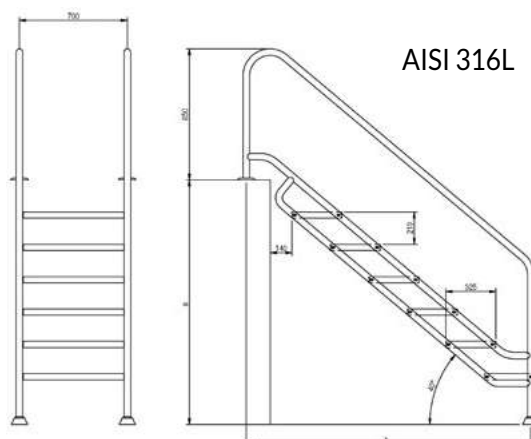



# ELEVADOR HIDRÁULICO - WB1

## HYDRAULIC LIFT – WB1

- Concebidos y diseñados para facilitar el acceso a la piscina de personas con movilidad reducida.

- *Conceived and designed to facilitate access to the pool for people with reduced mobility.*

- Elevador portátil, de montaje/transporte fácil y sin esfuerzo.
- De montaje inmediato y sin necesidad de permanencia fija, hecho que permite compartir un elevador entre varias piscinas.
- Gran equilibrio para el transporte: las dos ruedas en el cilindro central evitan oscilaciones durante el traslado.
- Sistema de fijación práctico y simple con un único anclaje empotrado y tres apoyos simples.
- Traslado de cara al agua y con reposapiés rígido para mayor confort y seguridad del usuario/a. (Existe opción de un reposapiés abatible).
- Con brazo de anclaje telescópico para adaptarse distintos tipos de rebosadero.
- Doble accionamiento, interior y exterior, para ofrecer mayor autonomía al usuario.
- Con estructura de acero inoxidable AISI 316L asiento de polipropileno, materiales aptos para exteriores.

- *Portable lift, easy to mount / transport and effortlessly.*

- *Immediate assembly and without the need for fixed permanence, a fact that allows sharing a lift between several pools.*

- *Great balance for transport: the two wheels on the central cylinder prevent oscillations during transport.*

- *Practical and simple fixing system with a single recessed anchor and three simple supports.*

- *Transfer facing the water and with rigid footrest for greater comfort and safety of the user. (There is an option of a folding footrest).*

- *With telescopic anchoring arm to adapt to different types of overflow.*

- *Double drive, inside and outside, to offer greater autonomy to the user.*

- *With AISI 316L stainless steel structure and polypropylene seat, materials suitable for outdoor use.*

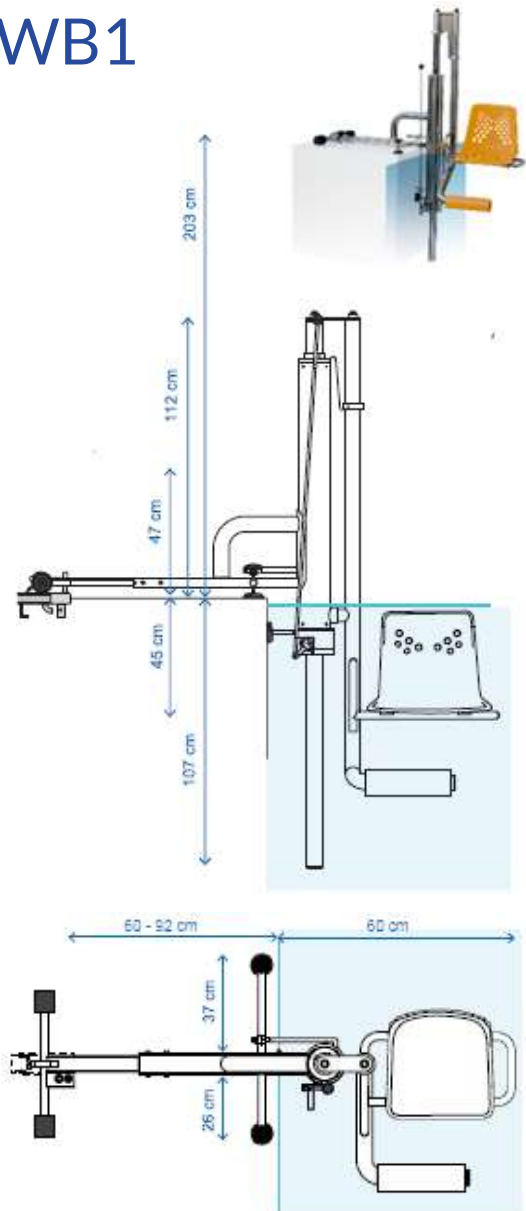

### Características Técnicas / Technical Features

Capacidad máx. Elevación / Max. Elevation: **140 kg**

Ángulo de giro / Turning angle: **150°**

Presión necesaria / Necessary pressure: **3,5 a 5 bares**

Brazo anclaje / Anchor arm:

Telescópico / Telescopic: **850-980mm**

Profundidad mínima / Minimum depth: **1,1m**

Peso / Weight: **54 kg**

Dimensiones / Dimensions: **2270x1300mm**

Es conforme con los requisitos esenciales de Seguridad y Salud de las Directivas: 98/37 CE "Máquinas" Y es conforme con las normas europeas armonizadas: UNE EN ISO 12100-1 / 12100-2 / 982 / 418 / 1050 / ISO 10535. It complies with the essential Health and Safety requirements of the Directives: 98/37 CE "Machines" And it complies with harmonized European standards: UNE EN ISO 12100-1 / 12100-2 / 982/418/1050 / ISO 10535.

# ELEVADOR HIDRÁULICO – WB2

## HYDRAULIC LIFT – WB2

- Concebidos y diseñados para facilitar el acceso a la piscina de personas con movilidad reducida.
- Elevador hidráulico con Sistema de anclaje fijo.
- Sistema de fijación simple, 3 tacos atornillados al pavimento y 3 apoyos simples.
- Traslado de cara al agua y con reposapiés rígido para mayor confort y seguridad del usuario/a. (Existe opción de un reposapiés abatible).
- Doble accionamiento, interior y exterior, para ofrecer mayor autonomía al usuario.
- Con estructura de acero inoxidable AISI 316L asiento de polipropileno, materiales aptos para exteriores.

- *Conceived and designed to facilitate access to the pool for people with reduced mobility.*
- *Hydraulic lift with fix anchor.*
- *Simple fixing system, with 3 screws and 3 simple supports.*
- *Transfer facing the water and with rigid footrest for greater comfort and safety of the user. (There is an option of a folding footrest).*
- *Double drive, inside and outside, to offer greater autonomy to the user.*
- *With AISI 316L stainless steel structure and polypropylene seat, materials suitable for outdoor use.*

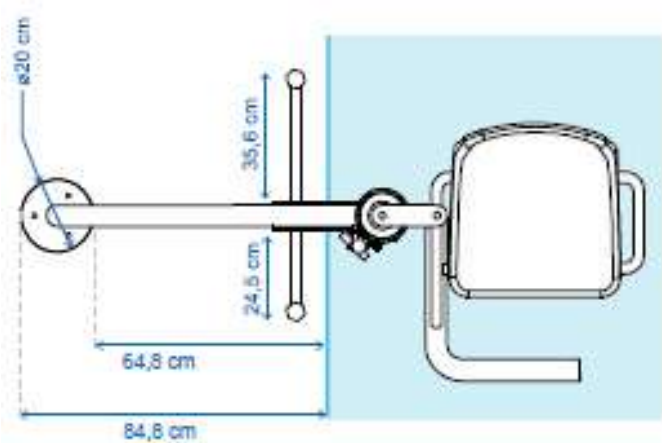

### Características Técnicas / Technical Features

Capacidad máx. Elevación / *Max. Elevation*: **140kg**

Ángulo de giro / *Turning angle*: **150°**

Presión necesaria / *Necessary pressure*: **3,5 a 5 bares**

Brazo anclaje / *Anchor arm*: **64,8cm**

Profundidad mínima / *Minimum depth*: **1,1m**

Peso / *Weight*: **54kg**

Dimensiones / *Dimensions*: **2270 x 1300mm**

Es conforme con los requisitos esenciales de Seguridad y Salud de las Directivas: 98/37 CE "Máquinas" Y es conforme con las normas europeas armonizadas: UNE EN ISO 12100-1 / 12100-2 / 982 / 418 / 1050 / ISO 10535 It complies with the essential Health and Safety requirements of the Directives: 98/37 CE "Machines" And it complies with harmonized European standards: UNE EN ISO 12100-1 / 12100-2 / 982/418/1050 / ISO 10535

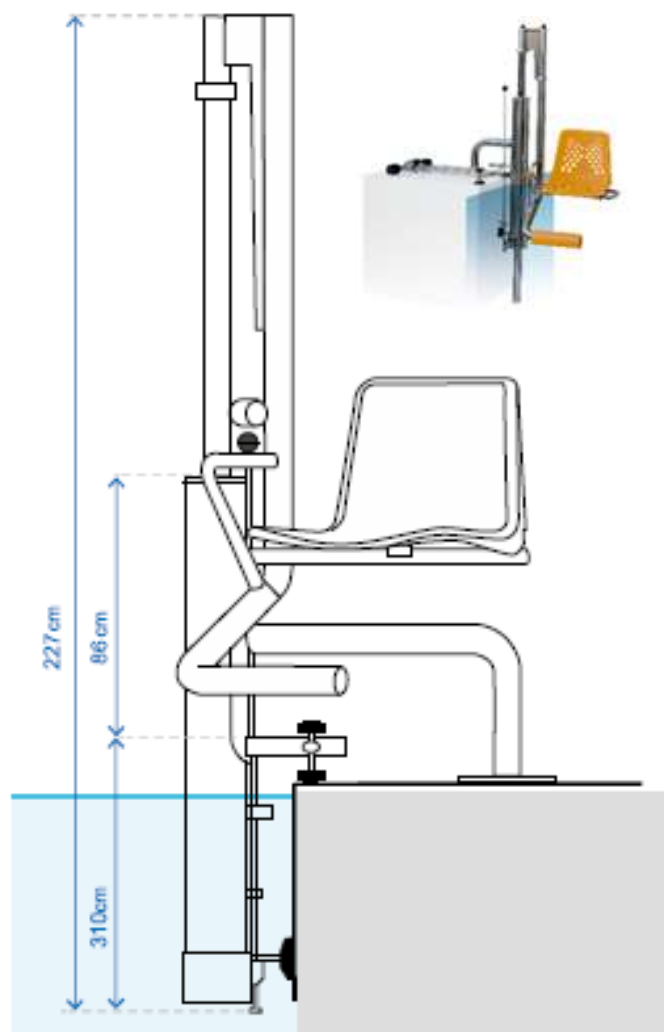

# PASAMANOS HANDRAILS

## FX-01

AISI 316L

Para empotrar  
*To be built-in*

Code

WF87168019

Pletina soldada  
*Welded flange*

Code

WF87168013

Incluye anclaje.  
*Anchorage included.*

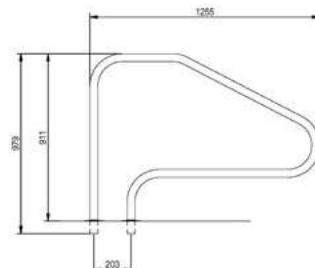

## FX-02

AISI 316L

Para empotrar  
*To be built-in*

Code

WF87168027

Pletina soldada  
*Welded flange*

Code

WF871680021

Incluye anclaje.  
*Anchorage included.*

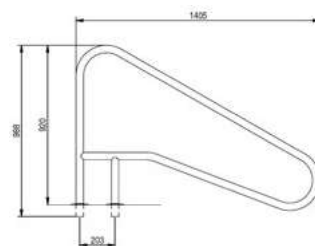

## FX-03

AISI 316L

Para empotrar *To be built-in*

Code

WF87166013

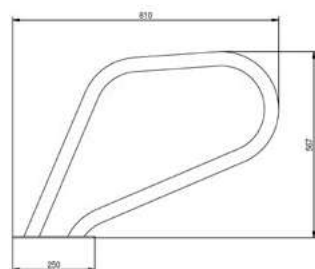

## FX-04

AISI 316L

Para empotrar  
*To be built-in*

Code

WF87164018

Pletina soldada  
*Welded flange*

Code

WF87164010

Incluye anclaje.  
*Anchorage included.*

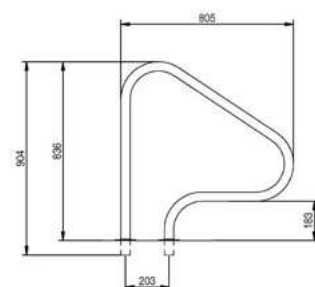

# PASAMANOS HANDRAILS

## FX-05

AISI 316L

Para empotrar *To be built-in*

Code	a. mm	b. mm
WF87162244	1219	660
WF87162251	1524	915
WF87162269	1829	1169

Incluye anclaje.  
*Anchorage included.*

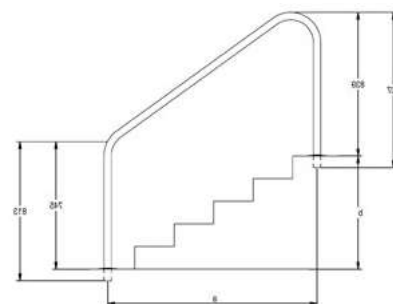

Pletina soldada *Welded flange*

Code	a. mm	b. mm
WF87162240	1219	660
WF87162250	1524	915
WF87162260	1829	1169

## FX-06

AISI 316L

Para empotrar *To be built-in*

Code
WF87162361

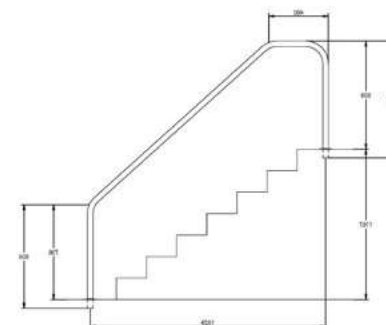

## JUEGO PASAMANOS PARTIDA TWO PIECES HANDRAILS SET

AISI 316L

Code
WF87101317N

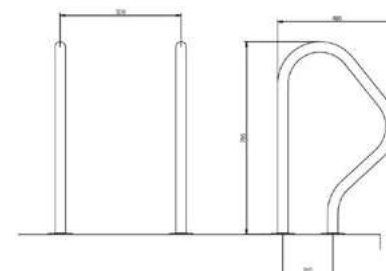
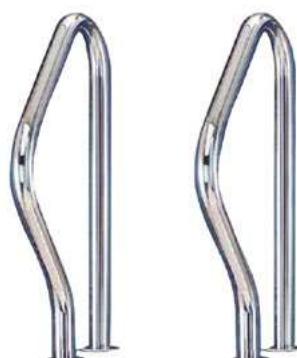

# PASAMANOS HANDRAILS

## PASAMANOS HANDRAILS Ø43mm

AISI 316L

Code	a. mm	u.
WF87180055	500	x1
WF87180105	1000	x1
WF87180154	1500	x1
WF87180204	2000	x1
WF87180303	3000	x1

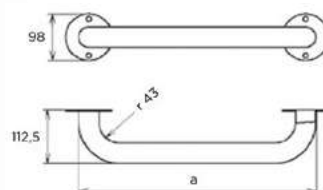

## ACCESORIOS PASAMANOS HANDRAIL ACCESSORIES SET

AISI 316L

Code	Ø	u.
WF87100831	*	x2

\*Para barandillas Ø 43. For handrails Ø 43.



## TUBO TUBE Ø43mm

AISI 316L

Code	a. mm	u.
WF87181010	1000	x4
WF87181020	2000	x4
WF87181030	3000	x4



## SOPORTE PARA TUBO WALL MOUNTING BRACKET

AISI 316L

Code	Desc.	u.
WF87180907 (A)	-	x4
WF87180915 (B)	Final	x4

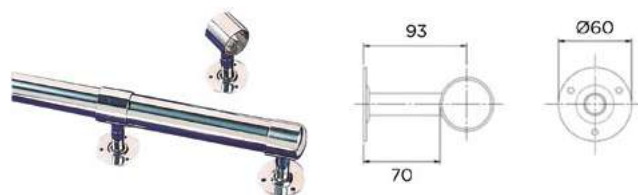

# PASAMANOS HANDRAILS

## CONEXIÓN TUBO TUBE CONNECTIONS Ø43mm

AISI 316L

Code	Desc.	u.
WF87181040 (C)	180°	x1
WF87181050 (D)	90°	x1



## TAPÓN TUBO STOPPER TUBE

PPA

Code	Ø	u.
WF87100220 (E)	43	x2



## KIT PARA LINER KIT FOR LINER

Para barandillas y escaleras Ø 43 *For handrails and ladders Ø 43*

Code	u.
WF87100021	x2



Para soporte tubo *For wall mounting bracket*

Code	u.
WF87100022	x2

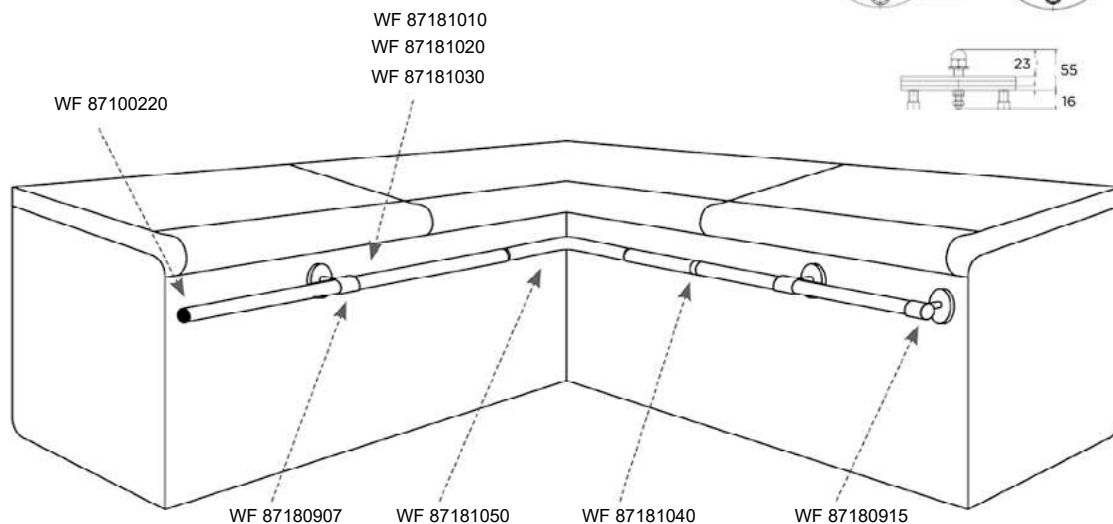
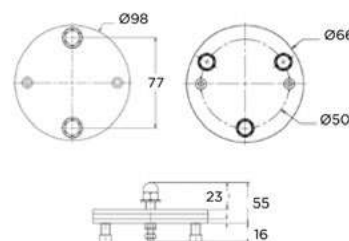

# DUCHAS SHOWERS

## ESTÁNDAR STANDARD

**Code**

WF87170049



Incluye anclaje  
Includes anchorage

- Carcasa exterior: Tubo de acero inoxidable AISI-304L, Ø 43mm, acabado brillante.
- Grifería: Latón cromado con embellecedores.
- Rociador: Latón cromado orientable.
- Componente interior: Tubo de acero inoxidable AISI-304L, Ø 1/2".
- Fijación: Anclaje con conexión equipotencial de puesta a tierra.
- UNE 20324 / EN 60529.
- Conexión: Mediante conexión rápida en el anclaje.
- Conexión de red: Hembra 1/2".
- *External housing: Stainless Steel tube AISI-304L, Ø 43mm, shiny finishing.*
- *Taps: Chrome-plated brass with trims.*
- *Shower head: Chrome-plated brass swivelling.*
- *Internal Component: Stainless Steel tube AISI-304L, Ø 1/2".*
- *Fixation: Anchorage with bonding earthing connection.*
- *UNE 20324 / EN 60529.*
- *Connection: By anchorage fase connection.*
- *Network connection: Female 1/2".*

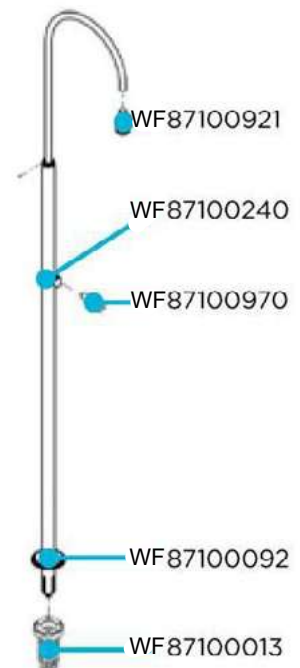
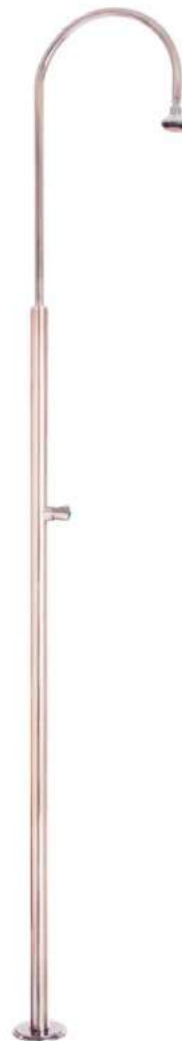
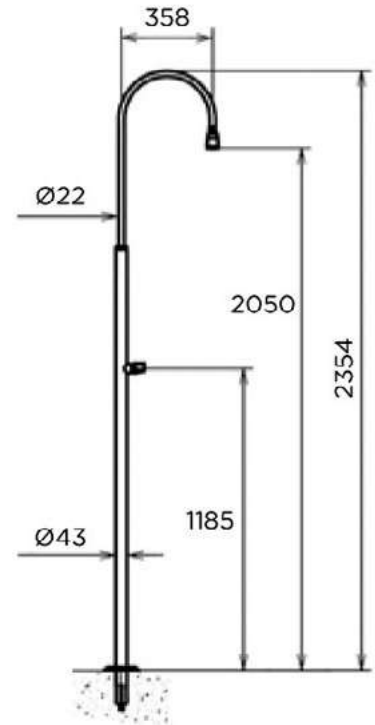

Code	Descripción Description
WF87100092	Embelledor Ø43 Escutcheon Ø43
WF87100921	Rociador Rose
WF87100970	Montura grifo Cartridge stem
WF87100240	Tornillo Screws
WF87100013	Anclaje Ø43 Anchorage Ø43

# DUCHAS SHOWERS

## CON LAVAPIÉS WITH FEET WASHER

Code

WF87170056



Incluye anclaje  
Includes anchorage

- Carcasa exterior: Tubo de acero inoxidable AISI-304L, Ø 43mm, acabado brillante.
- Ducha. Grifería: Latón cromado con embellecedores.
- Rociador: Latón cromado orientable.
- Lavapiés. Grifería: Latón cromado con embellecedor, rosca macho 1/2".
- Componente interior: Tubo de acero inoxidable AISI-304L, Ø 1/2".
- Fijación: Anclaje con conexión equipotencial de puesta a tierra.
- UNE 20324 / EN 60529.
- Conexión: Mediante conexión rápida en el anclaje.
- Conexión de red: Hembra 1/2".
- *External housing: Stainless Steel tube AISI-304L, Ø 43mm, shiny finishing.*
- *Shower. Taps: Chrome-plated brass with trims.*
- *Shower head: Chrome-plated brass swivelling. Feet washer.*
- *Taps: Chrome-plated brass with trim, male thread 1/2".*
- *Infernal Component: Stainless Steel tube AISI-304L, Ø 1/2".*
- *Fixation: Anchorage with bonding earthing connection.*
- *UNE 20324 / EN 60529.*
- *Connection: By anchoring fase connection.*
- *Network connection: Femafe 1/2".*

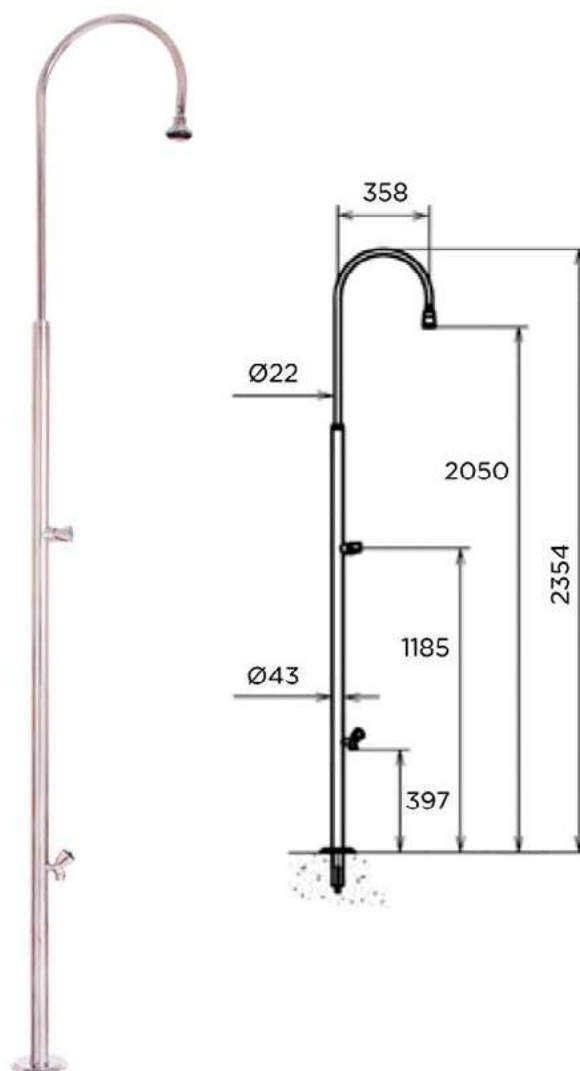

Code	Descripción Description
WF87100092	Embelledor Ø43 Escutcheon Ø43
WF87100921	Rociador Rose
WF87100970	Montura grifo Cartridge stem
WF87100972	Grifo lavapiés Feet washer
WF87100240	Tornillo Screws
WF87100013	Anclaje Ø43 Anchorage Ø43



# DUCHAS SHOWERS

## CON FLUXÓMETRO WITH FLUSHOMETER

**Code**  
WF87170064

Code	Ø	u.
WF87100939	635	x1



Anclaje necesario, COD. 87100939, no incluido.  
*Needs anchorage, COD. 87100939, not included.*

- Carcasa exterior: Tubo de acero inoxidable AISI-304L, Ø 63mm, acabado brillante.
  - Grifería: Pulsador Fluxómetro cromado con embellecedor.
  - Rociador: Cromado orientable.
  - Componente Interior: Tubo de acero inoxidable AISI-304L, Ø 1/2".
  - Fijación: Anclaje con conexión equipotencial de puesta a tierra. UNE 20324 / EN 60529.
  - Conexión: Mediante conexión rápida en el anclaje.
  - Conexión de red: Hembra 1/2".
- *External housing: Stainless Steel tube AISI-304L, Ø 63mm, shiny finishing.*
  - *Taps: Chrome-plated automatic valve with trim.*
  - *Shower head: Chrome-plated swivelling.*
  - *Internal component: Stainless Steel tube AISI-304L, Ø 1/2". Fixation: Anchorage with bonding earthing connection.*
  - *UNE 20324 / EN 60529.*
  - *Connection: By anchoring fase connection.*
  - *Network connection: Female 1/2".*

Code	Descripción Description
WF87100091	Embellecedor Ø 63 Escutcheon Ø 63
WF87100973	Pulsador fluxómetro Automatic
WF87100240	Tornillo Screw for shower
WF87100922	Rociador Rose
WF06004021	Cuerpo pulsador Brass body

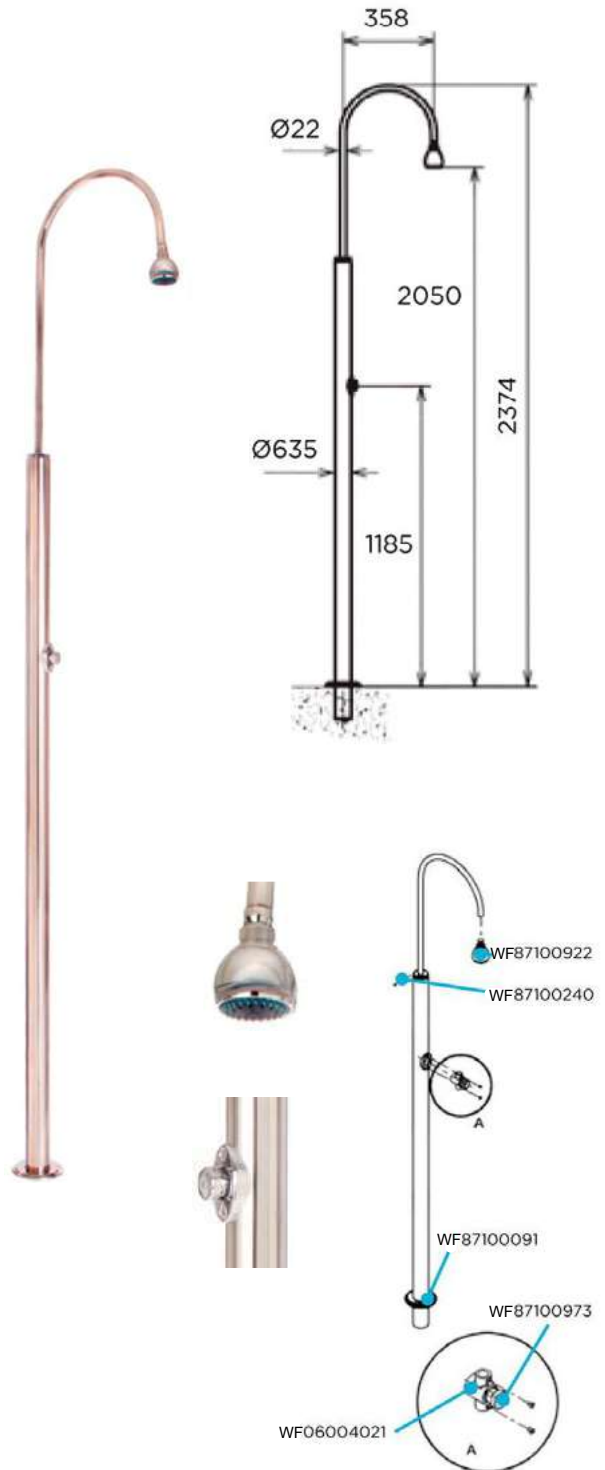

# DUCHAS SHOWERS

## DOBLE CON FLUXÓMETRO DOUBLE WITH FLUSHOMETER

Code

WF87170073

Code

WF87100922

Ø

635

u.

x1



Anclaje necesario, COD. WF87100922, no incluido.  
Needs anchorage, COD. WF87100922, not included..

- Carcasa exterior: Tubo de acero inoxidable AISI-304L, Ø 63mm, acabado brillante.
- Grifería: Pulsador Fluxómetro cromado con embellecedores.
- Rociador: Cromados orientables.
- Componente Interior: Tubo de acero inoxidable AISI-304L, Ø 1/2".
- Fijación: Anclaje con conexión equipotencial de puesta a tierra.
- UNE 20324 / EN 60529.
- Conexión: Mediante conexión rápida en el anclaje.
- Conexión de red: Hembra 1/2".

- *External housing: Stainless Steel tube AISI-304L, Ø 63mm, shiny finishing.*
- *Taps: Chrome-plated automatic valve with trim.*
- *Shower head: Chrome-plated swivelling.*
- *Interna' Component: Stainless Steel tube AISI-304L, Ø 1/2".*
- *Fixation: Anchorage with bonding earthing connection.*
- *UNE 20324 / EN 60529.*
- *Connection: By anchoring fase connection.*
- *Network connection: Female 1/2".*



# DUCHAS SHOWERS

## OVAL CON LAVAPIÉS

### OVAL WITH FEET WASHER

**Code**

WF87170012

Bajo pedido. *Upon request.*

- Carcasa exterior: Tubo de acero inoxidable AISI 304L, Ø 84mm, acabado brillante.
- Ducha: Grifería: Pulsador Fluxómetro cromado con embellecedor. Rociador: Latón Cromado.
- Lavapiés. Grifería: Pulsador Fluxómetro cromado con embellecedor. 70x100 Rociador: Latón Cromado.
- Componente interior: Latiguillo inoxidable, Ø 1/2".
- Fijación: Pletina roscada.
- Conexión de red: Rápida macho 1/2".
- *External housing: Stainless Steel tube AISI 304L, Ø 84mm, shiny finishing.*
- *Shower. Taps: Chrome-plated automatic valve with trim. Shower head: Chrome-plated brass.*
- *Feet washer. Taps: Chrome-plated automatic valve with trim.*
- *Shower head: Chrome-plated brass.*
- *Internal Component: Stainless steel hose, Ø 1/2".*

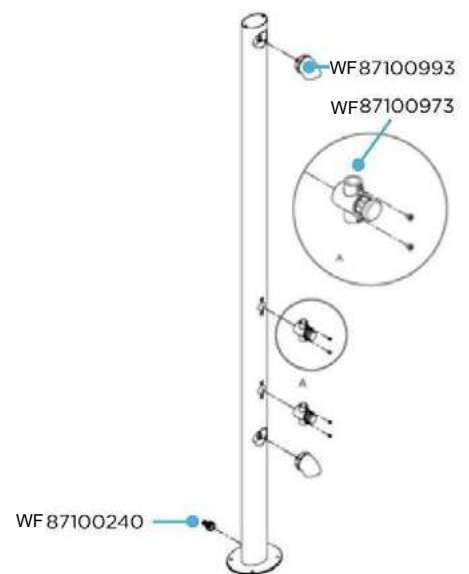
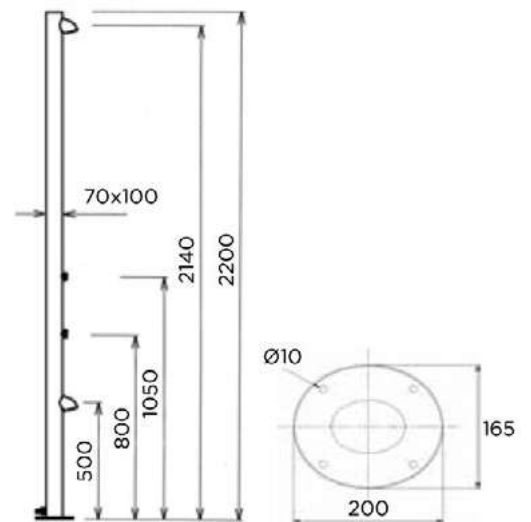

Code	Descripción Description
WF87100993	Rociador <i>Rose</i>
WF87100973	Manomando <i>Mixing tap</i>
WF87100240	Tornillo <i>Screws</i> (x 10 u.)

# DUCHAS SHOWERS

## SOLAR INOX 30L SS SOLAR 30L

### Code

WF87170092

- Autoportante.
- Frontal de ancho 67 mm AISI 304L.
- Rociador redondo de Ø 150 mm.
- Revestimiento especial y tratamiento anticorrosión.
- Entrada de agua de 1/2" macho.
- Conexión a entrada de agua mediante latiguillo flexible.
- Incluye conjunto anclaje: tornillos, tacos y arandelas.
- Tornillo de desagüe de acero inoxidable.
- *Freestanding.*
- *67 mm wide front panel AISI 304L.*
- *Ø 150 mm rounded shower head.*
- *Special coating and anticorrosive treatment.*
- *Male 1/2" main water supply.*
- *Connection through flexible water connector.*
- *Fixing set included: screws, anchors and washers.*
- *Drain plug.*

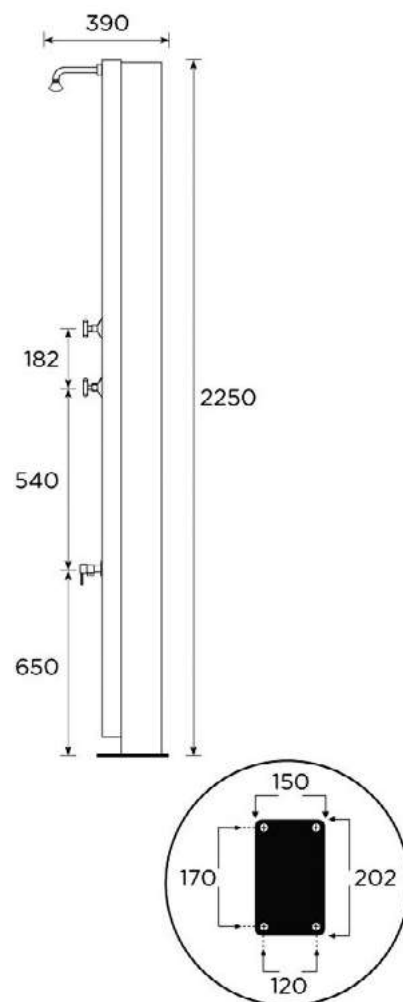

## DUCHAS SHOWERS

### SOLAR INOX 40L CON FLUXÓMETRO SS SOLAR 40L WITH FLUSHOMETER

#### Code

WF87170093

- Autoportable.
- Frontal de ancho 114 mm con diseño registrado AISI-316L. Rociador redondo de Ø 200 mm.
- Revestimiento especial y tratamiento anticorrosión.
- Entrada de agua de 1/2" hembra.
- Conexión a entrada de agua mediante latiguillo flexible.
- Incluye conjunto anclaje: tornillos, tacos y arandelas.
- Tornillo de desagüe de acero inoxidable.
- *Freestanding.*
- *114 mm wide and registered front panel design AISI-316L. Ø 200 mm rounded shower head.*
- *Special coating and anticorrosive treatment.*
- *Female 1/2" main water supply.*
- *Connection through flexible water connector.*
- *Fixing set included: screws, anchors and washers.*
- *Drain plug.*

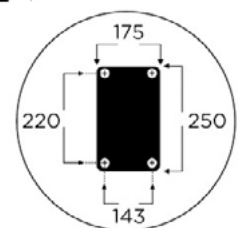
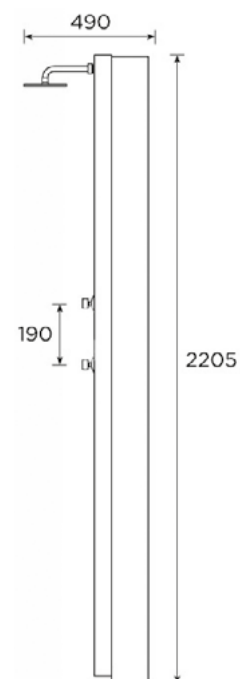

## EL TOQUE MÁGICO

Pocas cosas superan la vista de una piscina iluminada de noche. Para ello, tenemos en catálogo una selección de nichos, focos blancos y focos multicolor para impresionar a cualquier usuario.

## THE MAGICAL TOUCH

*Few things surpass the view of a pool illuminated at night. To do this, we have in our catalogue a selection of niches, white spotlights and multicolored spotlights to impress any user.*

# ILUMINACIÓN LIGHTING

# ILUMINACIÓN LIGHTING

## LED AMP SERIES

- Luz LED de alta calidad, con varios acabados transparente mate.
- Juego completo de accesorios para piscina de fibra, liner o hormigón.
- Fácil instalación y mantenimiento.
- Tecnología LED de alta intensidad.
- Disponible en color blanco o RGB (multicolor).
- Con control Remote opcional (RC) para una mayor comodidad.
- Cerramiento clase IP68.

Conexiones para piscinas de Fibra vidrio – Prefabricadas – liner.

*Fittings for Fiberglass pools – Pre-Fab pool – Vinyl pool.*

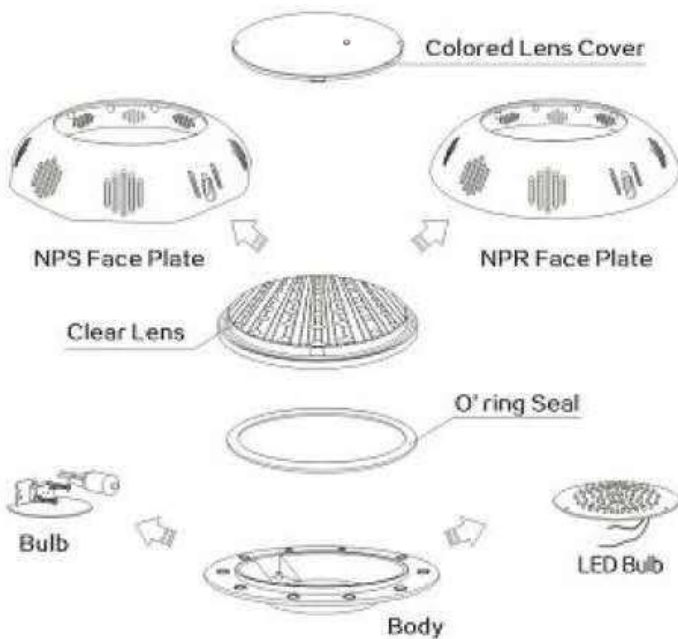
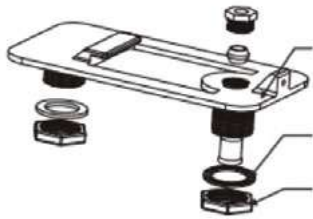

- LED lamp of high quality with several transparent matts finishes.
- Full fittings for fiberglass, vinyl or concrete swimming Pools.
- Easy to install and maintain.
- High intensity LED beam technology.
- Available in White or multi-color.
- Optional remote control (RC) allows you to manage The pool with an easygoing and relaxed lifestyle.
- Enclosure class IP68 water and dust proofing.

Conexiones para piscinas de hormigón.

*Fitting for concrete pools.*

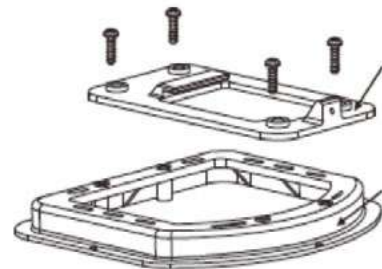

NATURAL NATURAL



PURPURA PURPLE



AZUL BLUE

	Description	Type of Pool	Type of color	LEDS	Power (W)	Voltage (V)	Remote Control
AMP100W	PLASTIC Halogen Light	Concrete/Prefab/ Liner	Warm White	NO	100	12	NO
AMP108	PLASTIC LED Light	Concrete/Prefab/ Liner	White	108	8.1	12	NO
AMP108RGB	PLASTIC LED Light	Concrete/Prefab/ Liner	RGB Color	108	8.1	12	NO
AMP108RGBRC	PLASTIC LED Light	Concrete/Prefab/ Liner	RGB Color	108	8.1	12	YES
AMP180	PLASTIC LED Light	Concrete/Prefab/ Liner	White	180	13.5	12	NO
AMP180RGB	PLASTIC LED Light	Concrete/Prefab/ Liner	RGB Color	180	13.5	12	NO
AMP180RGBRC	PLASTIC LED Light	Concrete/Prefab/ Liner	RGB Color	180	13.5	12	YES

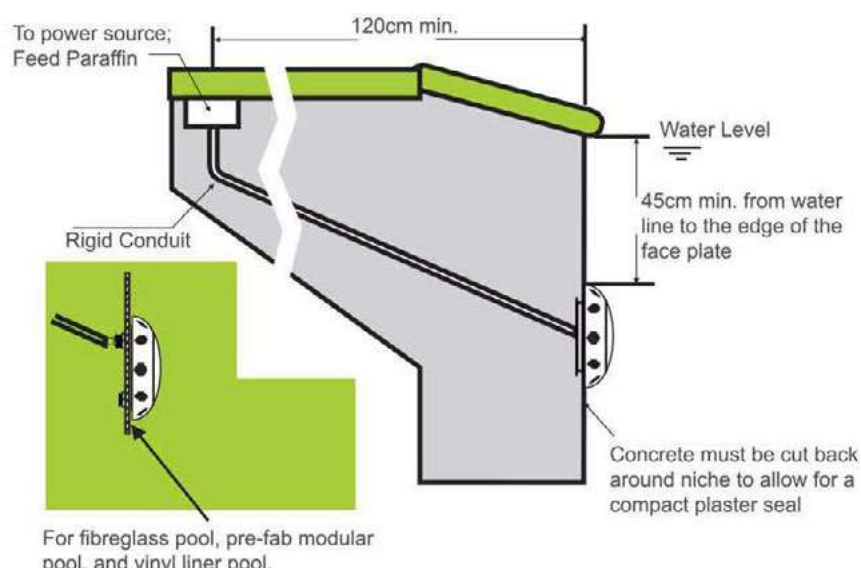
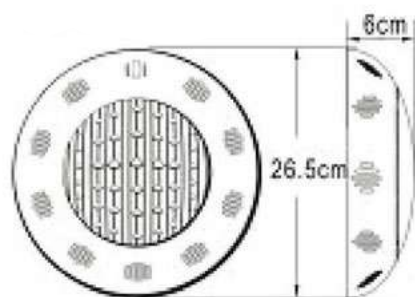



# ILUMINACIÓN LIGHTING

## LED AMS SERIES



- Luz LED de acero inoxidable de alta calidad.
- Fácil instalación y mantenimiento.
- Accesorios para colgar en pared.
- Tecnología LED de alta intensidad.
- Disponible en color blanco o RGB (multicolor).
- Con control remoto opcional (RC) para una mayor comodidad.
- Cerramiento clase IP68.
- Para piscinas de Hormigón

- *Stainless steel Premium LED lamp of high quality.*
- *Easy to install and maintain.*
- *Wall hanging fit.*
- *High intensity LED beam technology.*
- *Available in White or multi-color.*
- *Optional remote control (RC) allows you to manage the pool with an easygoing and relaxed lifestyle.*
- *Enclosure class IP68 water and dust proofing.*
- *For concrete pools*

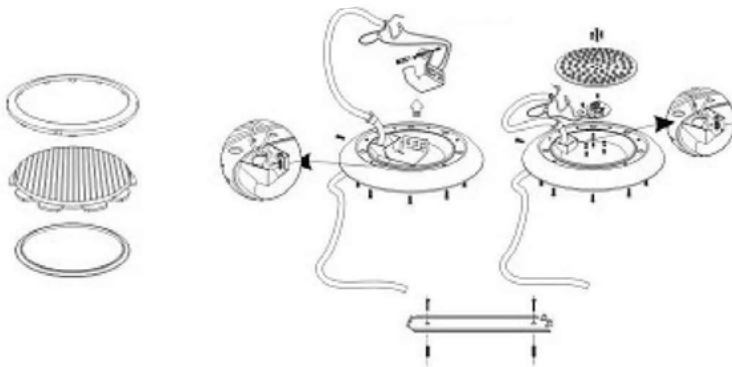
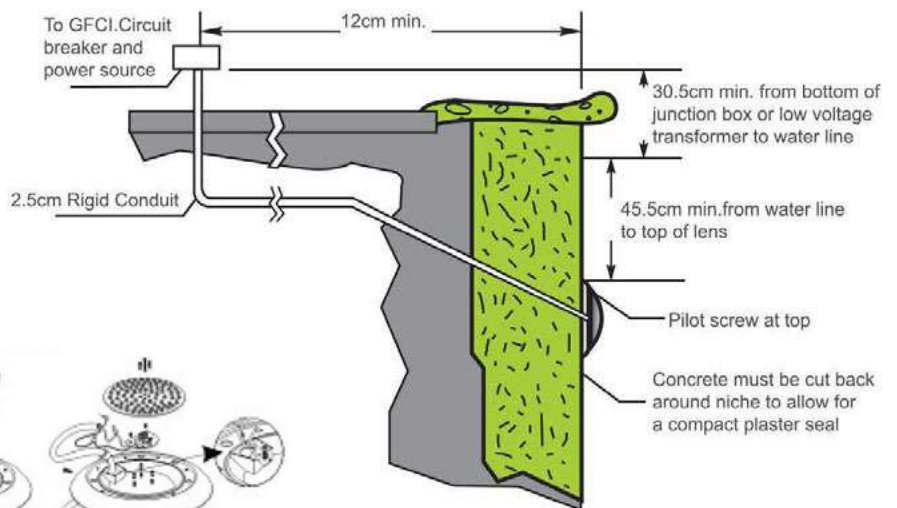
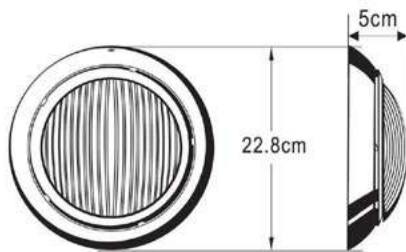

CODE	Description	Type of color	LEDS	Power (W)	Voltage (V)	Remote Control
AMS100W	Wall Mounted Halogen	Warm White	NO	100	12	NO
AMS108	Wall Mounted LED	White	108	8.1	12	NO
AMS108RGB	Wall Mounted LED	RGB Color	108	8.1	12	NO
AMS108RGBRC	Wall Mounted LED	RGB Color	108	8.1	12	YES
AMS180	Wall Mounted LED	White	180	13,5	12	NO
AMS180RGB	Wall Mounted LED	RGB Color	180	13,5	12	NO
AMS180RGBRC	Wall Mounted LED	RGB Color	180	13,5	12	YES

# TRANSFORMADOR TRANSFORMER

- Transformador para luces LED.
- Cerramiento clase IP68.
- ITS-GS, CE y UL aprobadas

- *Transformer for LED lights.*
- *Enclosure class IP68 water and dust proofing.*
- *ITS-GS, CE and UL approved.*



CODE	Power (w)	Input voltage (V)	Output voltage (V)	Weight (kg)
AMTR105	105	110/220-240	12	2.3
AMTR150	150			2.6
AMTR300	300			4.2
AMTR350	350			4.6
AMTR400	400			5.5
AMTR450	450			5.7
AMTR500	500			6

EQUIPOS DE DESINFECCIÓN Y CONTROL  
DISINFECTION AND CONTROL EQUIPMENT

# STATION STATION



Station es un controlador de toda la piscina que mantiene la calidad del agua en su óptimo estado dosificando productos químicos. El producto base controla la temperatura, los periodos de filtración, la iluminación y 4 relés adicionales. Este productos base se amplía añadiendo la medición y control de hasta 4 parámetros del agua. El manejo de los parámetros adicionales se puede añadir post-venta por medio de kit's de mejora.

*Disinfection by automatic metering of chemical products. Controls pH, redox, chlorine and conductivity. Measures and controls water quality with maximum precision. Automatically activates necessary adjustments. Allows up to 4 parameters in one single electronic unit.*

## PISCINAS RESIDENCIALES RESIDENTIAL SWIMMING POOLS

Ver opciones pág. 94  
See options page 94

Modelo	Descripción	Componentes
Model	Description	Components
DSST1	<p>Controlador de parámetros del agua y periodos de filtración e iluminación.</p> <p><i>Dosing equipment to monitor and control water parameters and entire pool.</i></p>	<p>Caja electrónica ampliable para la conexión de hasta 4 módulos de medida y control, 4 salidas analógicas y 2 entradas digitales. Incluye kit de comunicaciones R5485 (MODBUS).</p> <p><i>Electronic controller for filtration, light, temperature, 4 additional analog outputs and 2 digital inputs. Extendable for the control of up to 4 water promoters. Includes pre-installation remote control and MODBUS.</i></p>

Para el suministro del modelo ST1 es necesario escoger al menos 1 de los parámetros de controles automáticos opcionales (ver pág. 93).  
*ST1 can only be purchased in combination with at least one of the options for water parameter control (see page 93).*

**CÓMO ELEGIR EL EQUIPAMIENTO EN 3 PASOS**  
*SELECTION OF YOUR EQUIPMENT IN 3 STEPS*

- ESCOGER LOS CONTROLES AUTOMÁTICOS OPCIONALES (pH, redoX, Cloro Libre y conductividad). Ejemplo: DSST1 + pH + redoX = DSST1 BE**
- ESCOGER LA BOMBA DOSIFICADORA ADECUADA PARA EL VOLUMEN DE AGUA DE SU PISCINA.**

- CHOOSE THE OPTIONAL AUTOMATIC CONTROL (pH, redoX, Free Chlorine and Conductivity). Example: DSST1 + pH + redoX = DSST1 BE*
- CHOOSE THE RIGHT DOSING PUMP ACCORDING TO THE WATER VOLUME OF YOUR SWIMMING POOL.*

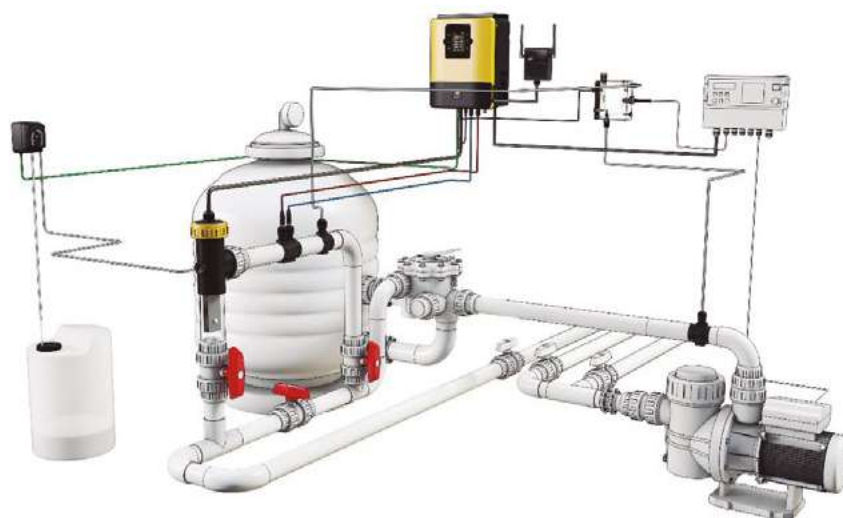

# HIDROLIFE - ELECTRÓLISIS SALINA SALT ELECTROLYSIS

## PISCINAS RESIDENCIALES RESIDENTIAL SWIMMING POOLS

Genera automáticamente el desinfectante hipoclorito sódico a base de agua ligeramente salada (>3gr sal/litro). Elimina la necesidad de añadir productos químicos para esterilizar el agua y acaba con malos olores causados por cloraminas.

*Automatically generates the disinfectant agent "sodium hypochlorite" out of water of low salinity (>3gr salt/liter). Sterilizes the water and eliminates unpleasant smells from bound chlorines (chloramines). You obtain clean healthy water without adding any chlorine or chemicals.*



Ver opciones pág. 94  
See options page 94

Modelo	Piscinas privadas hasta 28°C	Piscinas privadas +28°C	Descripción	Componentes
<i>Model</i>	<i>Private swimming pools up to 28°C</i>	<i>Private swimming pools +28°C</i>	<i>Description</i>	<i>Components</i>
DSSAL16	65 m <sup>3</sup>	40 m <sup>3</sup>	<b>Electrólisis salina 16 gr Cl<sub>2</sub>/h</b> <i>Salt electrolysis 16 gr Cl<sub>2</sub>/h</i>	<b>Caja electrónica / Célula titanio / Soporte PVC transparente 63 mm</b> <i>Electronic box / Titanium cell / Transparent PVC support 63 mm</i>
DSSAL22	110 m <sup>3</sup>	80 m <sup>3</sup>	<b>Electrólisis salina 22 gr Cl<sub>2</sub>/h</b> <i>Salt electrolysis 22 gr Cl<sub>2</sub>/h</i>	<b>Caja electrónica / Célula titanio / Soporte PVC transparente 63 mm</b> <i>Electronic box / Titanium cell / Transparent PVC support 63 mm</i>
DSSAL33	200 m <sup>3</sup>	125 m <sup>3</sup>	<b>Electrólisis salina 33 gr Cl<sub>2</sub>/h</b> <i>Salt electrolysis 33 gr Cl<sub>2</sub>/h</i>	<b>Caja electrónica / Célula titanio / Soporte PVC transparente 63 mm</b> <i>Electronic box / Titanium cell / Transparent PVC support 63 mm</i>
DSSAL50	250 m <sup>3</sup>	150 m <sup>3</sup>	<b>Electrólisis salina 50 gr Cl<sub>2</sub>/h</b> <i>Salt electrolysis 50 gr Cl<sub>2</sub>/h</i>	<b>Caja electrónica / Célula titanio / Soporte PVC transparente 63 mm</b> <i>Electronic box / Titanium cell / Transparent PVC support 63 mm</i>

# HIDROLIFE - ELECTRÓLISIS SALINA SALT ELECTROLYSIS



PISCINAS PÚBLICAS PUBLIC SWIMMING POOLS

Ver opciones pág. 94  
See options page 94

Modelo	Piscinas públicas	Descripción	Componentes
Model	Public swimming pools	Description	Components
DSSAL85	120 m <sup>3</sup>	<b>Electrólisis salina 85 gr Cl<sub>2</sub>/h</b> <i>Salt electrolysis 85 gr Cl<sub>2</sub>/h</i>	<b>Caja electrónica / Célula titanio / Soporte PVC transparente 110 mm</b> <i>Electronic box/Titanium cell /Transparent PVC support 110 mm</i>
DSSAL125	250 m <sup>3</sup>	<b>Electrólisis salina 125 gr Cl<sub>2</sub>/h</b> <i>Salt electrolysis 125 gr Cl<sub>2</sub>/h</i>	<b>Caja electrónica / Célula titanio / Soporte PVC transparente 110 mm</b> <i>Electronic box/Titanium cell /Transparent PVC support 110 mm</i>
DSSAL175	350 m <sup>3</sup>	<b>Electrólisis salina 175 gr Cl<sub>2</sub>/h</b> <i>Salt electrolysis 175 gr Cl<sub>2</sub>/h</i>	<b>Caja electrónica / Célula titanio / Soporte PVC transparente 110 mm</b> <i>Electronic box/Titanium cell /Transparent PVC support 110 mm</i>
DSSAL250	500 m <sup>3</sup>	<b>Electrólisis salina 250 gr Cl<sub>2</sub>/h</b> <i>Salt electrolysis 250 gr Cl<sub>2</sub>/h</i>	<b>Caja electrónica / Célula titanio / Soporte PVC transparente 140 mm</b> <i>Electronic box/Titanium cell /Transparent PVC support 140 mm</i>
DSSAL350	700 m <sup>3</sup>	<b>Electrólisis salina 350 gr Cl<sub>2</sub>/h</b> <i>Salt electrolysis 350 gr Cl<sub>2</sub>/h</i>	<b>Cajas electrónicas / 2 Células titanio / 2 Soportes PVC transparente 110 mm</b> <i>Electronic boxes / 2 Titanium cells / 2 Transparent PVC supports 110 mm</i>
DSSAL500	1000 m <sup>3</sup>	<b>Electrólisis salina 500 gr Cl<sub>2</sub>/h</b> <i>Salt electrolysis 500 gr Cl<sub>2</sub>/h</i>	<b>Cajas electrónicas / 2 Células titanio / 2 Soportes PVC transparente 140 mm</b> <i>Electronic boxes / 2 Titanium cells / 2 Transparent PVC supports 140 mm</i>

## CÓMO ELEGIR EL EQUIPAMIENTO EN 3 PASOS SELECTION OF YOUR EQUIPMENT IN 3 STEPS

- ESCOGER EL MODELO DE CAJA ELECTRÓNICA DE ACUERDO CON LAS CARACTERÍSTICAS DE LA PISCINA (privada exterior o interior, piscina pública, temperatura ambiente y m<sup>3</sup>). Ejemplo: Piscina privada exterior, hasta 28°C, 65m<sup>3</sup> = DSSAL16
  - ESCOGER LOS CONTROLES AUTOMÁTICOS OPCIONALES (sin controles, Control pH, Control redoX, Control Cloro Libre, Control Salinidad y Detector de Flujo). Ejemplo: DSSAL 16 + Control pH + Control redoX = DSSAL16 BE
  - ESCOGER LA BOMBA DOSIFICADORA ADECUADA PARA EL VOLUMEN DE AGUA DE PISCINA.
- CHOOSE YOUR ELECTRONIC BOX ACCORDING TO THE CHARACTERISTICS OF YOUR SWIMMING POOL (private outdoor or indoor swimming pool, public swimming pool, water temperature and m<sup>3</sup>). Example: Private outdoor swimming pool, up to 28°C, 65m<sup>3</sup> = DSSAL16
  - CHOOSE THE OPTIONAL AUTOMATIC CONTROL (No control, pH control, redoX control, Free Chlorine Control, Salinity Control and Flow Detector). Example: DSSAL 16 + Control pH + Control redoX = DSSAL16 BE
  - CHOOSE THE RIGHT DOSING PUMP ACCORDING TO THE WATER VOLUMEN OF YOUR SWIMMING POOL.

# AQUASCENIC - ELECTRÓLISIS DE BAJA SALINIDAD. HIDRÓLISIS E IONIZACIÓN CU/AG

## LOW SALINITY ELECTROLYSIS, HYDROLYSIS AND IONIZATION(CU/AG)

Aquascenic emplea tres métodos de desinfección para una perfecta esterilización del agua, sin necesidad de añadir ningún tipo de producto químico. La hidrólisis rompe la molécula de agua (H2O) en hidrogeno y oxígeno (H y O), generando así agentes de desinfección a base de oxígeno (O3, O2, OH·, H2O2...). La electrólisis usa los cloruros presentes en el agua para producir HClO (desinfectante). Además utiliza la ionización de cobre y plata (algicida, bactericida y floculante) para generar un desinfectante residual.



Ver opciones pág. 94  
See options page 94

## PISCINAS RESIDENCIALES RESIDENTIAL SWIMMING POOLS

Modelo	Piscinas privadas hasta 28°C	Piscinas privadas +28°C	Descripción	Componentes
Model	Private swimming pools up to 28°C	Private swimming pools +28°C	Description	Components
DSHD1	65 m³	40 m³	<b>Hidrólisis 15 + Floculación por ionización Cu/Ag</b> <i>Hidrolysis 15 + Flocculation via ionization of Cu/Ag</i>	<b>Caja electrónica / Célula titanio / Soporte PVC transparente 63 mm / Vaso de ionización 2e</b> <i>Electronic box / Titanium cell / Transparent PVC support 63 mm / Ionization chamber 2e</i>
DSHD2	100 m³	80 m³	<b>Hidrólisis 30 + Floculación por ionización Cu/Ag</b> <i>Hidrolysis 30 + Flocculation via ionization of Cu/Ag</i>	<b>Caja electrónica / Célula titanio / Soporte PVC transparente 63 mm / Vaso de ionización 4e</b> <i>Electronic box / Titanium cell / Transparent PVC support 63 mm / Ionization chamber 4e</i>
DSHD3	200 m³	125 m³	<b>Hidrólisis 50 + Floculación por ionización Cu/Ag</b> <i>Hidrolysis 50 + Flocculation via ionization of Cu/Ag</i>	<b>Caja electrónica / Célula titanio / Soporte PVC transparente 63 mm / Vaso de ionización 6e</b> <i>Electronic box/Titanium cell/Transparent PVC support 63 mm / Ionization chamber 6e</i>

### CÓMO ELEGIR EL EQUIPAMIENTO EN 3 PASOS SELECTION OF YOUR EQUIPMENT IN 3 STEPS

1. ESCOGER EL MODELO DE CAJA ELECTRÓNICA DE ACUERDO CON LAS CARACTERÍSTICAS DE LA PISCINA (privada exterior o interior, piscina pública, temperatura ambiente y m³). Ejemplo: Piscina privada exterior, hasta 28°C, 65m³ = DSHD1
  2. ESCOGER LOS CONTROLES AUTOMÁTICOS OPCIONALES (sin controles, Control pH, Control redoX, Control Cloro Libre, Control Salinidad y Detector de Flujo). Ejemplo: DSHD1 + Control pH + Control redoX = DSHD1 BE
  3. ESCOGER LA BOMBA DOSIFICADORA ADECUADA PARA EL VOLUMEN DE AGUA DE PISCINA.
1. CHOOSE YOUR ELECTRONIC BOX ACCORDING TO THE CHARACTERISTICS OF YOUR SWIMMING POOL (private outdoor or indoor swimming pool, public swimming pool, water temperature and m³). Example: Private outdoor swimming pool, up to 28°C, 65m³ = DSHD1
  2. CHOOSE THE OPTIONAL AUTOMATIC CONTROL (No control, pH control, redoX control, Free Chlorine Control, Salinity Control and Flow Detector). Example: DSHD1+ Control pH + Control redoX = DSHD1 BE
  3. CHOOSE THE RIGHT DOSING PUMP ACCORDING TO THE WATER VOLUMEN OF YOUR SWIMMING POOL.

# AQUASCENIC - ELECTRÓLISIS DE BAJA SALINIDAD. HIDRÓLISIS E IONIZACIÓN CU/AG

## LOW SALINITY ELECTROLYSIS, HYDROLYSIS AND IONIZATION(CU/AG)

Aquascenic employs three methods of disinfection for perfect sterilization of water, without without the need to add any type of chemicals. The hydrolysis breaks the water molecule (H<sub>2</sub>O) in hydrogen and oxygen (H and O), thus generating disinfection agents based on oxygen (O<sub>3</sub>, O<sub>2</sub>, OH<sup>-</sup>, H<sub>2</sub>O<sub>2</sub>...). Electrolysis uses chlorides present in the water to produce HClO (disinfectant). Also uses the ionization of copper and silver (algacide, bactericide and flocculant) to generate a residual disinfectant.



Ver opciones pág. 94  
See options page 94

## PISCINAS PÚBLICA PUBLIC SWIMMING POOLS

Modelo	Piscinas públicas	Descripción	Componentes
Model	Public swimming pools	Description	Components
DSHD4	65 m <sup>3</sup>	<b>Hidrólisis 85 + Floculación por ionización Cu/Ag</b> <i>Hidrolysis 85 + Flocculation for Cu/Ag ionization</i>	<b>Caja electrónica / Célula titanio / Soporte PVC transparente 110 mm / Vaso de ionización 8e</b> <i>Electronic box / Titanium cell / Transparent PVC support 110 mm / Ionization chamber 8e</i>
DSHD5	120 m <sup>3</sup>	<b>Hidrólisis 120 + Floculación por ionización Cu/Ag</b> <i>Hidrolysis 120 + Flocculation for Cu/Ag ionization</i>	<b>Caja electrónica / Célula titanio / Soporte PVC transparente 110 mm / Vaso de ionización 10e</b> <i>Electronic box / Titanium cell / Transparent PVC support 110 mm / Ionization chamber 10e</i>
DSHD6	250 m <sup>3</sup>	<b>Hidrólisis 175 + Floculación por ionización Cu/Ag</b> <i>Hidrolysis 175 + Flocculation for Cu/Ag ionization</i>	<b>Caja electrónica / Célula titanio / Soporte PVC transparente 110 mm / Vaso de ionización 12e</b> <i>Electronic box / Titanium cell / Transparent PVC support 110 mm / Ionization chamber 12e</i>
DSHD7	350 m <sup>3</sup>	<b>Hidrólisis 250 + Floculación por ionización Cu/Ag</b> <i>Hidrolysis 250 + Flocculation for Cu/Ag ionization</i>	<b>Caja electrónica / Célula titanio / Soporte PVC transparente 140 mm / Vaso de ionización 12e</b> <i>Electronic box / Titanium cell / Transparent PVC support 140 mm / Ionization chamber 12e</i>
DSHD8	500 m <sup>3</sup>	<b>Hidrólisis 350 + Floculación por ionización Cu/Ag</b> <i>Hidrolysis 350 + Flocculation for Cu/Ag ionization</i>	<b>2 Cajas electrónicas / 2 Células titanio / 2 Soportes PVC transparente 110 mm / Vaso de ionización 12e</b> <i>2 Electronic boxes / 2 Titanium cells / 2 Transparent PVC supports 110 mm / Ionization chamber 12e</i>
DSHD9	750 m <sup>3</sup>	<b>Hidrólisis 500 + Floculación por ionización Cu/Ag</b> <i>Hidrolysis 500 + Flocculation for Cu/Ag ionization</i>	<b>2 Cajas electrónicas / 2 Células titanio / 2 Soportes PVC transparente 140 mm / Vaso de ionización 12e</b> <i>2 Electronic boxes / 2 Titanium cells / 2 Transparent PVC supports 140 mm / Ionization chamber 12e</i>



# OXILIFE - BAJA SALINIDAD E HIDRÓLISIS

## LOW SALINITY AND HYDROLYSIS

Oxilife emplea dos métodos de desinfección para una perfecta esterilización del agua, sin necesidad de añadir ningún tipo de producto químico. La hidrólisis rompe la molécula de agua ( $H_2O$ ) en hidrógeno y oxígeno (H y O), generando así agentes de desinfección a base de oxígeno ( $O_3$ ,  $O_2$ , OH,  $H_2O_2$ ...). Además utiliza la electrólisis salina de baja salinidad (>1,5 g/litro) para generar Cloro residual.



### PISCINAS RESIDENCIALES

#### RESIDENTIAL SWIMMING POOLS

Ver opciones pág. 94  
See options page 94

Modelo	Piscinas privadas hasta 28°C	Piscinas privadas +28°C	Descripción	Componentes
<i>Model</i>	<i>Private swimming pools up to 28°C</i>	<i>Private swimming pools +28°C</i>	<i>Description</i>	<i>Components</i>
DSOX0	20 m <sup>3</sup>	10 m <sup>3</sup>	<b>Hidrólisis 8</b> <i>Hydrolysis 8</i>	<b>Caja electrónica / Célula titanio / Soporte PVC transparente 63 mm</b> <i>Electronic box / Titanium cell / Transparent PVC support 63 mm</i>
DSOX1	60 m <sup>3</sup>	40 m <sup>3</sup>	<b>Hidrólisis 15</b> <i>Hydrolysis 15</i>	<b>Caja electrónica / Célula titanio / Soporte PVC transparente 63 mm</b> <i>Electronic box / Titanium cell / Transparent PVC support 63 mm</i>
DSOX2	120 m <sup>3</sup>	80 m <sup>3</sup>	<b>Hidrólisis 30</b> <i>Hydrolysis 30</i>	<b>Caja electrónica / Célula titanio / Soporte PVC transparente 63 mm</b> <i>Electronic box / Titanium cell / Transparent PVC support 63 mm</i>
DSOX3	150 m <sup>3</sup>	125 m <sup>3</sup>	<b>Hidrólisis 50</b> <i>Hydrolysis 50</i>	<b>Caja electrónica / Célula titanio / Soporte PVC transparente 63 mm</b> <i>Electronic box / Titanium cell / Transparent PVC support 63 mm</i>

#### CÓMO ELEGIR EL EQUIPAMIENTO EN 3 PASOS SELECTION OF YOUR EQUIPMENT IN 3 STEPS

- ESCOGER EL MODELO DE CAJA ELECTRÓNICA DE ACUERDO CON LAS CARACTERÍSTICAS DE LA PISCINA** (privada exterior o interior, piscina pública, temperatura ambiente y m<sup>3</sup>). Ejemplo: Piscina privada exterior, hasta 28°C, 20m<sup>3</sup> = DSOX0
  - ESCOGER LOS CONTROLES AUTOMÁTICOS OPCIONALES** (sin controles, Control pH, Control redoX, Control Cloro Libre, Control Salinidad y Detector de Flujo). Ejemplo: DSOX0 + Control pH + Control redoX = DSOX0 BE
  - ESCOGER LA BOMBA DOSIFICADORA ADECUADA PARA EL VOLUMEN DE AGUA DE PISCINA.**
- CHOOSE YOUR ELECTRONIC BOX ACCORDING TO THE CHARACTERISTICS OF YOUR SWIMMING POOL** (private outdoor or indoor swimming pool, public swimming pool, water temperature and m<sup>3</sup>). Example: Private outdoor swimming pool, up to 28°C, 20m<sup>3</sup> = DSOX0
  - CHOOSE THE OPTIONAL AUTOMATIC CONTROL** (No control, pH control, redoX control, Free Chlorine Control, Salinity Control and Flow Detector). Example: DSHD1+ Control pH + Control redoX = DSOX0 BE
  - CHOOSE THE RIGHT DOSING PUMP ACCORDING TO THE WATER VOLUMEN OF YOUR SWIMMING POOL.**

# OXILIFE - BAJA SALINIDAD E HIDRÓLISIS

## LOW SALINITY AND HYDROLYSIS

Oxilife uses two disinfection methods to accomplish a perfect sterilization of the pool water without adding any chemicals. Via hydrolysis the water molecule is broken into its components hydrogen and oxygen (H and O) which then recombine into strong disinfection agents ( $O_3$ ,  $O_2$ , OH,  $H_2O_2$ ...). Additionally salt water electrolysis of low salinity (>1,15 g/liter) is used to produce a residual chlorine level in the pool.



### PISCINAS PÚBLICAS

#### PUBLIC SWIMMING POOLS

Ver opciones pág. 94  
See options page 94

Modelo	Piscinas públicas	Descripción	Componentes
Model	Public swimming pools	Description	Components
DSOX4	65 m <sup>3</sup>	<b>Hidrólisis</b> <b>85 gr Cl<sub>2</sub>/h</b> <i>Salt electrolysis 80 gr Cl<sub>2</sub>/h</i>	<b>Caja electrónica / Célula titanio / Soporte PVC transparente 110 mm</b> <i>Electronic box/Titanium cell/Transparent PVC support 110 mm</i>
DSOX5	120 m <sup>3</sup>	<b>Hidrólisis</b> <b>125 gr Cl<sub>2</sub>/h</b> <i>Salt electrolysis 120 gr Cl<sub>2</sub>/h</i>	<b>Caja electrónica / Célula titanio / Soporte PVC transparente 110 mm</b> <i>Electronic box/Titanium cell/Transparent PVC support 110 mm</i>
DSOX6	250 m <sup>3</sup>	<b>Hidrólisis</b> <b>175 gr Cl<sub>2</sub>/h</b> <i>Salt electrolysis 175 gr Cl<sub>2</sub>/h</i>	<b>Caja electrónica / Célula titanio / Soporte PVC transparente 110 mm</b> <i>Electronic box/Titanium cell/Transparent PVC support 110 mm</i>
DSOX7	350 m <sup>3</sup>	<b>Hidrólisis</b> <b>250 gr Cl<sub>2</sub>/h</b> <i>Salt electrolysis 250 gr Cl<sub>2</sub>/h</i>	<b>Caja electrónica / Célula titanio / Soporte PVC transparente 140 mm</b> <i>Electronic box/Titanium cell/Transparent PVC support 140 mm</i>
DSOX8	500 m <sup>3</sup>	<b>Hidrólisis</b> <b>350 gr Cl<sub>2</sub>/h</b> <i>Salt electrolysis 350 gr Cl<sub>2</sub>/h</i>	<b>Cajas electrónicas / 2 Células titanio / 2 Soportes PVC transparente 110 mm</b> <i>Electronic boxes / 2 Titanium cells / 2 Transparent PVC supports 110 mm</i>
DSOX9	750 m <sup>3</sup>	<b>Hidrólisis</b> <b>500 gr Cl<sub>2</sub>/h</b> <i>Salt electrolysis 500 gr Cl<sub>2</sub>/h</i>	<b>Cajas electrónicas / 2 Células titanio / 2 Soportes PVC transparente 140 mm</b> <i>Electronic boxes / 2 Titanium cells / 2 Transparent PVC supports 140 mm</i>

# BIONET - ELECTRÓLISIS E IONIZACIÓN CU/AG

## SALT ELECTROLYSIS AND IONIZATION CU/AG

**SISTEMA EXCLUSIVO PARA UNA AGUA EL DOBLE DE SANA**  
**EXCLUSIVE SYSTEM FOR HEALTHIER WATER**

Bionet emplea dos métodos de desinfección para una perfecta esterilización del agua, sin necesidad de añadir ningún tipo de producto químico. Genera automáticamente el desinfectante hipoclorito sódico a base de agua ligeramente salada (>3 g Sal/litro). Además utiliza la ionización de cobre y plata (algicida, bactericida y floculante) para generar un desinfectante y floculante adicional.



Ver opciones pág. 94  
 See options page 94

### PISCINAS RESIDENCIALES

#### RESIDENTIAL SWIMMING POOLS

Modelo	Piscinas privadas hasta 28°C <i>Private swimming pools up to 28°C</i>	Piscinas privadas +28°C <i>Private swimming pools +28°C</i>	Descripción	Componentes
Model			Description	Components
DSBIO16	65 m <sup>3</sup>	40 m <sup>3</sup>	<b>Electrólisis salina 16 gr Cl<sub>2</sub>/h + Floculación por ionización Cu/Ag</b> <i>Salt Electrolysis 16 gr Cl<sub>2</sub>/h + Flocculation via Cu/Ag ionization</i>	Caja electrónica / Célula titanio / Soporte PVC transparente 63 mm / Vaso de ionización 2e <i>Electronic box / Titanium cell / Transparent PVC support 63 mm / Ionization chamber 2e</i>
DSBIO22	110 m <sup>3</sup>	80 m <sup>3</sup>	<b>Electrólisis salina 22 gr Cl<sub>2</sub>/h + Floculación por ionización Cu/Ag</b> <i>Salt Electrolysis 22 gr Cl<sub>2</sub>/h + Flocculation via Cu/Ag ionization</i>	Caja electrónica / Célula titanio / Soporte PVC transparente 63 mm / Vaso de ionización 4e <i>Electronic box / Titanium cell / Transparent PVC support 63 mm / Ionization chamber 4e</i>
DSBIO33	200 m <sup>3</sup>	125 m <sup>3</sup>	<b>Electrólisis salina 33 gr Cl<sub>2</sub>/h + Floculación por ionización Cu/Ag</b> <i>Salt Electrolysis 33 gr Cl<sub>2</sub>/h + Flocculation via Cu/Ag ionization</i>	Caja electrónica / Célula titanio / Soporte PVC transparente 63 mm / Vaso de ionización 6e <i>Electronic box / Titanium cell / Transparent PVC support 63 mm / Ionization chamber 6e</i>
DSBIO50	250 m <sup>3</sup>	150 m <sup>3</sup>	<b>Electrólisis salina 50 gr Cl<sub>2</sub>/h + Floculación por ionización Cu/Ag</b> <i>Salt Electrolysis 50 gr Cl<sub>2</sub>/h + Flocculation via Cu/Ag ionization</i>	Caja electrónica / Célula titanio / Soporte PVC transparente 63 mm / Vaso de ionización 8e <i>Electronic box / Titanium cell / Transparent PVC support 63 mm / Ionization chamber 8e</i>

**CÓMO ELEGIR EL EQUIPAMIENTO EN 3 PASOS** *SELECTION OF YOUR EQUIPMENT IN 3 STEPS*

- ESCOGER EL MODELO DE CAJA ELECTRÓNICA DE ACUERDO CON LAS CARACTERÍSTICAS DE LA PISCINA** (privada exterior o interior, piscina pública, temperatura de agua y m<sup>3</sup>). Ejemplo: Piscina privada exterior, hasta 280, 65 m<sup>3</sup> = DSB1016
  - ESCOGER LOS CONTROLES AUTOMÁTICOS OPCIONALES** (Sin controles, Control pH, Control redox, Control Cloro Libre, Control Salinidad y Detector de Flujo). Ejemplo: DSB1016 + Control pH + Control redoX = DSBIOI 6 BE
  - ESCOGER LA BOMBA DOSIFICADORA ADECUADA PARA EL VOLUMEN DE AGUA DE SU PISCINA.**
- CHOOSE YOUR ELECTRONIC BOX ACCORDING TO THE CHARACTERISTICS OF YOUR SWIMMING POOL** (private outdoor or indoor swimming pool, public swimming pool, water temperature and m<sup>3</sup>). Example: Private outdoor swimming pool, up to 280, 65 m<sup>3</sup> = DSB1016
  - CHOOSE THE OPTIONAL AUTOMATIC CONTROL** (No control, pH control, redoX control, Free Chlorine control, Salinity control and Flow detector). Example: DSB1016 + pH control + redoX control = DSB1016 BE
  - CHOOSE THE RIGHT DOSING PUMP ACCORDING TO THE WATER VOLUME OF YOUR SWIMMING POOL.**

# BIONET - ELECTRÓLISIS E IONIZACIÓN CU/AG

## SALT ELECTROLYSIS AND IONIZATION CU/AG

**SISTEMA EXCLUSIVO PARA UNA AGUA EL DOBLE DE SANA**  
**EXCLUSIVE SYSTEM FOR HEALTHIER WATER**

Bionet uses two disinfection methods to accomplish a perfect sterilization of the pool water without adding any chemicals. It automatically generates the disinfectant agent "sodium hypochlorite" out of water of low salinity (>3 g Salt/liter). Ionization of Copper and Silver (flocculation and sterilization) is used to produce an additional disinfectant and flocculent effect in the pool.



## PISCINAS PÚBLICAS

### PUBLIC SWIMMING POOLS

Ver opciones pág. 94  
 See options page 94

Modelo	Piscinas públicas	Descripción	Componentes
Model	Public swimming pools	Description	Components
DSBIO85	120 m <sup>3</sup>	<b>Electrólisis salina 85 grCl<sub>2</sub>/h + Flocculación por ionización Cu/Ag</b> <i>Salt Electrolysis 85 grCl<sub>2</sub>/h + Flocculation via Cu/Ag ionization</i>	<b>Caja electrónica / Célula titanio / Soporte PVC transparente 110 mm / Vaso Ionización 10e</b> <i>Electronic box / Titanium cell / Transparent PVC support 110 mm / Ionization chamber 10e</i>
DSBIO125	250 m <sup>3</sup>	<b>Electrólisis salina 125 grCl<sub>2</sub>/h + Flocculación por ionización Cu/Ag</b> <i>Salt Electrolysis 125 grCl<sub>2</sub>/h + Flocculation via Cu/Ag ionization</i>	<b>Caja electrónica / Célula titanio / Soporte PVC transparente 110 mm / Vaso Ionización 12e</b> <i>Electronic box / Titanium cell / Transparent PVC support 110 mm / Ionization chamber 12e</i>
DSBIO175	350 m <sup>3</sup>	<b>Electrólisis salina 175 grCl<sub>2</sub>/h + Flocculación por ionización Cu/Ag</b> <i>Salt Electrolysis 175 grCl<sub>2</sub>/h + Flocculation via Cu/Ag ionization</i>	<b>Caja electrónica / Célula titanio / Soporte PVC transparente 110 mm / Vaso Ionización 12e</b> <i>Electronic box / Titanium cell / Transparent PVC support 110 mm / Ionization chamber 12e</i>
DSBIO250	500 m <sup>3</sup>	<b>Electrólisis salina 250 grCl<sub>2</sub>/h + Flocculación por ionización Cu/Ag</b> <i>Salt Electrolysis 250 grCl<sub>2</sub>/h + Flocculation via Cu/Ag ionization</i>	<b>Caja electrónica / Célula titanio / Soporte PVC transparente 140 mm / Vaso Ionización 12e</b> <i>Electronic box / Titanium cell / Transparent PVC support 140 mm / Ionization chamber 12e</i>
DSBIO350	700 m <sup>3</sup>	<b>Electrólisis salina 350 grCl<sub>2</sub>/h + Flocculación por ionización Cu/Ag</b> <i>Salt Electrolysis 350 grCl<sub>2</sub>/h + Flocculation via Cu/Ag ionization</i>	<b>2 cajas electrónicas / 2 células titanio / 2 soportes PVC transparente 110 mm / Vaso de ionización 12e</b> <i>2 electronic boxes / 2 titanium cells / 2 PVC transparent supports 110 mm / Ionization chamber 12e</i>
DSBIO500	1000 m <sup>3</sup>	<b>Electrólisis salina 500 grCl<sub>2</sub>/h + Flocculación por ionización Cu/Ag</b> <i>Salt Electrolysis 500 grCl<sub>2</sub>/h + Flocculation via Cu/Ag ionization</i>	<b>2 cajas electrónicas / 2 células titanio / 2 soportes PVC transparente 140 mm / Vaso de ionización 12e</b> <i>2 electronic boxes / 2 titanium cells / 2 PVC transparent supports 140 mm / Ionization chamber 12e</i>

# UVSCENIC - ELECTRÓLISIS BAJA SALINIDAD, HIDRÓLISIS Y TECNOLOGÍA UV

## LOW SALINITY ELECTROLYSIS, HIDROLYSIS AND UV TECHNOLOGY

El sistema UVscenic emplea dos métodos de desinfección para una perfecta esterilización del agua, sin añadir ningún tipo de producto químico. Por un lado se generan oxidantes a través de electrólisis de baja salinidad (desde 1,5 gr/NaCl), por otro lado se somete el agua a una radiación UV-C que ayuda adicionalmente a neutralizar bacterias, virus y otros organismos primarios.



### PISCINAS RESIDENCIALES RESIDENTIAL SWIMMING POOLS

Ver opciones pág. 94  
See options page 94

Modelo	Piscinas privadas hasta 28°C	Piscinas privadas +28°C	Descripción	Componentes
Model	Private swimming pools up to 28°C	Private swimming pools +28°C	Description	Components
DSUV1	100 m <sup>3</sup>		Ultravioleta Ultraviolet	Soporte 63-50 mm / 2 lámparas ultravioleta 55 W unid. Support 63-50 mm / 2 ultraviolet lamps 55 W/unit
DSUV16	65 m <sup>3</sup>	40 m <sup>3</sup>	Ultravioleta + Electrólisis 16 de baja salinidad (desde 1,5 gr/l NaCl) Ultraviolet + Low salinity electrolysis 16 (from 1,5 gr/l NaCl)	Caja electrónica / Soporte UV 50-63 mm / 2 lámparas ultravioleta 55 W unid. / Celula titanio / Soporte PVC transparente 63 mm Electronic box / UV support 50-63 mm / 2 ultraviolet lamps 55 W-unit / Titanium cell / Transparent PVC support 63 mm
DSUV33	100 m <sup>3</sup>	80 m <sup>3</sup>	Ultravioleta + Electrólisis 33 de baja salinidad (desde 1,5 gr/l NaCl) Ultraviolet + Low salinity electrolysis 33 (from 1,5 gr/l NaCl)	Caja electrónica / Soporte UV 50-63 mm / 2 lámparas ultravioleta 55 W unid. / Celula titanio / Soporte PVC transparente 63 mm Electronic box / UV support 50-63 mm / 2 ultraviolet lamps 55 W-unit / Titanium cell / Transparent PVC support 63 mm
DSUV50	200 m <sup>3</sup>	125 m <sup>3</sup>	Ultravioleta + Electrólisis 50 de baja salinidad (desde 1,5 gr/l NaCl) Ultraviolet + Low salinity electrolysis 50 (from 1,5 gr/l NaCl)	Caja electrónica / Soporte UV 50-63 mm / 2 lámparas ultravioleta 55 W unid. / Celula titanio / Soporte PVC transparente 63 mm Electronic box / UV support 50-63 mm / 2 ultraviolet lamps 55 W-unit / Titanium cell / Transparent PVC support 63 mm

#### CÓMO ELEGIR EL EQUIPAMIENTO EN 3 PASOS SELECTION OF YOUR EQUIPMENT IN 3 STEPS

- ESCOGER EL MODELO DE CAJA ELECTRÓNICA DE ACUERDO CON LAS CARACTERÍSTICAS DE LA PISCINA (privada exterior o interior, piscina pública, temperatura ambiente y m<sup>3</sup>). Ej.: Piscina privada exterior, hasta 280, 100 m<sup>3</sup> = DSUV1
  - ESCOGER LOS CONTROLES AUTOMÁTICOS OPCIONALES (Sin controles, Control pH, Control redox, Control Cloro Libre, Control Salinidad y Detector de Flujo). Ej.: DSUV1 + Control pH + Control redoX = DSUV1 BE
  - ESCOGER LA BOMBA DOSIFICADORA ADECUADA PARA EL VOLUMEN DE AGUA DE SU PISCINA.
- CHOOSE YOUR ELECTRONIC BOX ACCORDING TO THE CHARACTERISTICS OF YOUR SWIMMING POOL (private outdoor or indoor swimming pool, public swimming pool, water temperature and m<sup>3</sup>). Example: Private outdoor swimming pool, up to 280, 100 DSUV1
  - CHOOSE THE OPTIONAL AUTOMATIC CONTROL (No control, pH control, redoX control, Free Chlorine control, Salinity control and Flow detector). Example: DSUV1 + pH control + redoX control = DSUV1 BE
  - CHOOSE THE RIGHT DOSING PUMP ACCORDING TO THE WATER VOLUME OF YOUR SWIMMING POOL.

# UVSCENIC - ELECTRÓLISIS BAJA SALINIDAD, HIDRÓLISIS Y TECNOLOGÍA UV

## LOW SALINITY ELECTROLYSIS, HIDROLYSIS AND UV TECHNOLOGY

The UVscenic includes two methods of disinfection to accomplish a perfect sterilisation of the pool water without adding any chemicals. The low salinity electrolysis (from 1,5 gr/NaCl) produces persistent oxidants. The water is also exposed to UV-C radiation which additionally helps neutralize bacteria, viruses and germs.















### PISCINAS PÚBLICAS PUBLIC SWIMMING POOLS



Ver opciones pág. 94  
See options page 94

Modelo	Piscinas públicas	Descripción	Componentes
Model	Public swimming pools	Description	Components
DSUV85	125 m <sup>3</sup>	<b>Ultravioleta + Electrólisis 85 de baja salinidad (desde 1,5 gr/l NaCl)</b> <i>Ultraviolet + Low salinity electrolysis 85 (from 1,5 gr/l NaCl)</i>	<b>Caja electrónica / Soporte UV 50-63 mm / 2 lámparas ultravioleta 55 W unid. / Celula titanio / Soporte PVC transparente 110 mm</b> <i>Electronic box / UV support 50-63 mm / 2 ultraviolet lamps 55 W-unit / Titanium cell / Transparent PVC support 110 mm</i>
DSUV125	220 m <sup>3</sup>	<b>Ultravioleta + Electrólisis 125 de baja salinidad (desde 1,5 gr/l NaCl)</b> <i>Ultraviolet + Low salinity electrolysis 125 (from 1,5 gr/l NaCl)</i>	<b>Caja electrónica / Soporte UV 50-63 mm / 4 lámparas ultravioleta 55 W unid. / Celula titanio / Soporte PVC transparente 110 mm</b> <i>Electronic box / UV support 50-63 mm / 4 ultraviolet lamps 55 W-unit / Titanium cell / Transparent PVC support 110 mm</i>
DSUV175	300 m <sup>3</sup>	<b>Ultravioleta + Electrólisis 175 de baja salinidad (desde 1,5 gr/l NaCl)</b> <i>Ultraviolet + Low salinity electrolysis 175 (from 1,5 gr/l NaCl)</i>	<b>Caja electrónica / Soporte UV 50-63 mm / 4 lámparas ultravioleta 55 W unid. / Celula titanio / Soporte PVC transparente 110 mm</b> <i>Electronic box / UV support 50-63 mm / 4 ultraviolet lamps 55 W-unit / Titanium cell / Transparent PVC support 110 mm</i>
DSUV250	400 m <sup>3</sup>	<b>Ultravioleta + Electrólisis 250 de baja salinidad (desde 1,5 gr/l NaCl)</b> <i>Ultraviolet + Low salinity electrolysis 250 (from 1,5 gr/l NaCl)</i>	<b>Caja electrónica / Soporte UV 50-63 mm / 6 lámparas ultravioleta 55 W unid. / Celula titanio / Soporte PVC transparente 140 mm</b> <i>Electronic box / UV support 50-63 mm / 6 ultraviolet lamps 55 W-unit / Titanium cell / Transparent PVC support 140 mm</i>

# CONTROLES OPCIONALES OPTIONAL CONTROLS

Prod.	Ref.	Controles automáticos	Descripción	Componentes
Prod.	Ref.	Automatic controls	Description	Components
	DSA	Sin controles No controls		
	DSB	Control pH ácido pH control (acid)	Medición y control del pH del agua. Display and management of pH.	1 medidor de pH / 1 soporte sonda / 1 salida 220 V con conector para bomba / Patrones. Electronics (software/hardware)/ 1 pH probe / 1 probe holder / 1 220V output (includes pump connector)/ Buffers.
	DSBg	Control pH ácido pH control (acid)	Vaso de cristal Glass cristal	Chip electrónico / 1 sonda de pH CRISTAL / 1 soporte sonda by-pass / 1 porta sonda / Patrones / (pH7, pH10, Neutra). Electronic chip / 1 pH glass probe / 1 probe support/ 1 probe by-pass holder / Buffers (pH7, pH10, Neutra).
	DSE	Control redoX redox control	Medición y control del redoX como valor del control del cloro libre. Controla la puesta en marcha y paro de la electrólisis salina. Measurement and control of redoX value. Controls the on/off of the salt electrolysis.	1 medidor de redoX / 1 sonda de redoX / 1 soporte sonda. Electronics (software/hardware)/ 1 redoX probe / 1 probe holder.
	DSEg	Control redoX redox control	Vaso de cristal Glass cristal	Chip electrónico / 1 sonda de redoX CRISTAL / 1 soporte sonda by-pass / 1 porta sonda / Patrones / (465mV, Neutra) Electronic chip / 1 redoX glass probe / 1 probe support/ 1 probe holder / Buffers (465mV, neutral).
	DSH	Control cloro libre Free chlorine control	Medición y control de ppm's del cloro libre del agua. Controla la puesta en marcha y paro de la electrólisis salina. Measurement and control free chlorine (ppm's) in the water. Controls the on/off of the salt electrolysis.	1 medidor cloro libre / 1 sonda amperométrica / 1 rotámetro transparente / 1 sensor inductivo. 1 free chlorine measurer / 1 amperometric probe / 1 transparent methacrylate holder/ 1 inductive sensor.
	DSI	Control salinidad* Salinity control*	Medición y control de la conductividad del agua en Msiemens. Measurement and control of conductivity value.	1 salida 220 V con conector para apertura / cierre de válvula motorizada para purga o dosificación de sal. 1 120 V output (includes pump / automatic valve connector).
	DSJ	Detector de flujo Flow detector	Entrada para detector de flujo mecánico de seguridad para detener la electrólisis salina por falta de caudal de agua. Input for security mechanical flow detector to stop salt electrolysis when there is no flow.	1 conector doble especial, circuito electrónico, detector plástico y collarín soporte. 1 special double connector, electronic circuit, paddle plastic detector and support.
	DST	Módulo temperatura Temperature module	Sonda temperatura activa control de filtración por temperatura (modos smart / calefacción / inteligente). Active filtration control by temperature / (smart / intelligent / heating modes).	Sonda temperatura 1/2" /soporte sonda. Temperature probe 1/2" / probe holder.
	DSRS 3WI	Módulo WiFi WiFi module	Modelos 2016. Envía los datos de puerto serie por WiFi (para instalaciones con cobertura WiFi en el local técnico de filtración). 2016 models. Sends data by WiFi (for installations within range of WiFi signal).	Módulo WiFi / 2 m cable / antena WiFi. WiFi module / 2 m wire / antenna WiFi.
	DSRS 2NET	Módulo Ethernet Ethernet module	Módulo Ethernet (con cable - no incluido). Ethernet module (with cable - not included).	Módulo Ethernet / 2 m cable. Ethernet module / 2 m cable.
	DSRS 150	Soporte display remoto Portable display holder	Soporte mural de superficie para colocación remota de display. Wall mounting kit in order to position the colour display externally.	Soporte negro ABS / tornillería sujeción / tapa display / 10 m cable y conectores. Black ABS housing / O m cable and connectors / cap for unit.
	DSRS1 HDMI	Módulo HDMI HDMI module	Visualiza las medidas de pH, Cloro Libre, etc. en pantalla HDMI. Incluye sensor de temperatura y humedad del ambiente. REQUIERE DSRS2WI. Displays pH, free Chlorine, etc... measures HDMI screens. Includes temperature and humidity sensor. REQUIRES DSRS2WI.	Caja electrónica y cable HDMI. Electronic box and HDMI connector.

## BOMBAS DOSIFICADORAS DOSING PUMPS

	DSKBPer	Peristáltica 1,5 l/h Peristaltic 1,5 l/h
	DSKB5-5	Electromagnética 5 l/h Electromagnetic 5 l/h

Consulte con nuestro equipo para la perfecta combinación de equipamiento opcional.  
Please consult with our team for the perfect combination of optional equipment.





\*No se vende como opcional, tiene que pedirse junto al equipo deseado.  
\*Can not be sold as an optional, it must ask for along with the equipment.

# PVC PVC













- Trabajamos cualquier medida desde  $\varnothing 16$  hasta  $\varnothing 400$ mm.
- Conexiones en milímetros (mm) y en pulgadas (NPT).
- Para más accesorios de PVC, pida nuestro catálogo completo.

- We can supply any measure from  $\varnothing 16$  to  $\varnothing 400$ mm.
- Connections in millimeters (mm) and in inches (NPT).
- For more PVC accessories, please ask for our complete catalogue.

		Diameter	Code
 <p><b>Codo 90° para encolar</b> <i>Solvent socket 90° elbow</i></p>		50mm	RH1001004
		63mm	RH1001005
		75mm	RH1001006
 <p><b>Codo 45° para encolar</b> <i>Solvent socket 45° elbow</i></p>		50mm	RH1001016
		63mm	RH1001017
		75mm	RH1001018
 <p><b>Te igual 90° para encolar</b> <i>Plain 90° tee</i></p>		50mm	RH1001028
		63mm	RH1001029
		75mm	RH1001030
 <p><b>Te 45° para encolar</b> <i>Plain 45° tee</i></p>		50mm	RH1001345
		63mm	RH1001346
		75mm	RH1001347



		Diameter	Code
	Manguito unión liso para encolar <i>Plain coupling</i>	50mm	RH1001040
		63mm	RH1001041
		75mm	RH1001042
	Casquillo reductor para encolar <i>Reducing bush</i>	63/50mm	RH1001065
		75/63mm	RH1001066
		90/75mm	RH1001067
	Machón mixto para encolar y RM <i>Plain threaded nipple</i>	40/50x1½"	RH1002743
		50/63x2"	RH1002754
		63/75x2½"	RH1002765
	Terminal rosca macho <i>Male threaded adaptor</i>	50-1½"	RH1002005
		63-2"	RH1002006
		75-2½"	RH1002007
	Enlace 3 piezas para encolar <i>Union, female plain socket-female plain socket</i>	50mm	RH1001083
		63mm	RH1001084
		75mm	RH1001085
	Enlace 3 piezas mixto macho-hembra <i>Union, plain socket-female thread</i>	1½"-50	RH1002032
		2"-63	RH1002033
		2½"-75	RH1002034
	Tapón para encolar <i>Cap solvent socket</i>	50mm	RH1001052
		63mm	RH1001053
		75mm	RH1001054
	Válvula bola PE "basic" para encolar <i>"Basic" ball valve solvent socket outlet</i>	50mm	RH1011078
		63mm	RH1011079
		75mm	RH1011080
	Válvula antirretorno de enlace <i>Check valve solvent socket outlet</i>	50mm	RH1016005
		63mm	RH1016006
		75mm	RH1016007
	Válvula mariposa gatillo-EPDM <i>Compact valve catch handle</i>	90mm	RH1009603
		110mm	RH1009604
		125mm	RH1009605
		140mm	RH1009606
	Válvula mariposa gatillo/brida-EPDM <i>Compact valve with flanges/catch handle</i>	160mm	RH1009607
		90mm	RH1009615
		110mm	RH1009616
		125mm	RH1009617
		140mm	RH1009618
		160mm	RH1009619



CLIMATIZACIÓN CLIMATIZATION

# CLIMATIZACIÓN CLIMATIZATION

## ENFRIADORA CHILLER



Diseño exclusivo para spas y para cualquier tipo de bañera. Se conecta directamente a la toma de corriente de la vivienda, calentando o enfriando el agua en pocas horas hasta 2°C.

### CARACTERÍSTICAS

#### Diseño compacto.

La bomba de circulación de agua, filtro de agua, dispositivo de desinfección con ozono y dispositivo de esterilización UV están integrados dentro del armario de la enfriadora.

#### Instalación y funcionalidad simples. Control remoto Smart APP

Fácil de instalar y conectar. Con un simple control para ajustar la temperatura a la medida de su experiencia. Todo vía WIFI.

#### Calentamiento y enfriamiento

La comodidad de poder calentar o enfriar el agua a la temperatura que desees.

*Exclusive design for spas and small pools. It connects directly to the home socket, heating or cooling the water in a few hours up to 2°C.*

### CHARACTERISTICS

#### Compact design

*The water pump with self-priming system, water filter, ozone disinfection device and UV sterilization device are built inside the Ice Bath Chiller's cabinet.*

#### Simple Installation & Functionality. Smart APP remote control

*Easy to install and connect. With a simple control to adjust the temperature to suit your experience. All via WIFI with APP.*

#### Warming up and cooling down

*The comfort of being able to heat or cool the bath to the temperature you want.*



MODEL	NDE-20-FIB	NDE-25-FIB	NDE-30-FIB
Type	Heating & Cooling		
Water Volume & Chilling Time (from 23°C to 5°C)	50L: ≤0,8h	50L: ≤0,65h	50L: ≤0,55h
	100L: ≤ 1,65h	100L: ≤1,35h	100L: ≤ 1,1h
	200L: ≤ 3,3h	200L: ≤2,7h	200L: ≤2,2h
	300L: ≤5h	300L: ≤ 4,1h	300L: ≤ 3,3h
	500L: ≤83h	500L: ≤6.75h	500L: ≤55h
colling* Capacidad(kW)	15 ~ 40		
Noise (db(A)) (1m)	2 ~ 28		
Heat exchanger	-5 ~ 43		
Cooling Ambient: 27°C, Water Outlet 10°C			
Cooling Capacity (W)	1535	1820	2400
Power Input (W)	573	672	854
Current Value (A)	2,49	2,92	3,71
EER	2,68	2,71	2,81
Cooling Ambient: 15°C, Water Outlet 2°C			
Cooling Capacity (W)	1535	1625	2190
Power Input (W)	454	482	664
Current Value (A)	1,97	2,1	2,85
EER	3,38	3,37	3,3
Heating Ambient: 15°C, Water hlet 26°C, Humidity: 80%			
Heatng Capacity (W)	3200	4210	5100
Power Input (W)	498	663	728
Current Value (A)	2,17	2,88	3,17
COP	6,43	6,35	7,01
Heating Ambient: 15°C, Water hlet 26°C, Humidity: 70%			
Heatng Capacity (W)	2180	2550	3740
Power Input (W)	530	646	837
Current Value (A)	2,31	2,81	3,64
COP	4,11	3,95	4,47
Pump hput Power (W)	65		
Power Supply	220-240V ~50hz		
Refrigerant	R32		
Sound Pressure Level at 10m [dB(A)]	32	34	36
Water Pipe Connection (mm)	Ø20		
Water Heat Exchanger	Titanium		
Circuation Pump	Built in UV Sterilizer		
Disinfection	Built in Ozone Generator		
Water Filter	Builtin		
Net Weight (kg)	30	33	36
Net Dimensions L x W x H (mm)	489x437x500		539x437x500

# CLIMATIZACIÓN CLIMATIZATION

## ENFRIADORA + BAÑERA ALL-IN-ONE



El sistema de enfriado está instalado dentro de la bañera y el panel de control en uno de los laterales para un mejor manejo de la misma

### CARACTERÍSTICAS

#### Diseño compacto.

Todo los elementos integrados para una fácil instalación, incluso para los usuarios (bomba de circulación de agua, filtro de agua y dispositivo de desinfección con Ozono).

#### VENTAJAS

- Conectividad APP para un gran confort.
- Bañera acrílica para una máxima comodidad y durabilidad.
- Diseño ergonómico en su interior para una máxima relajación.
- Con una capa única de fibra de vidrio y espuma para garantizar el máximo aislamiento y acortar el tiempo de enfriamiento.
- Equipado con una cubierta para evitar pérdidas de temperatura cuando no se usa.

The chiller system is installed inside the specific acrylic bathtub and the wire controller is mounted on the side panel of the bathtub.

### CHARACTERISTICS

#### Compact design

All-in-One, highly integrated for saving installation space. Water pump with self-priming system, water filter and ozone disinfection device.

#### ADVANTAGES

- Connect to APP for your comfort.
- No extra installation work, easy to use for end users.
- The bathtub design is ergonomic and the semi-lying style can make people more relaxed.
- Unique fiberglass and foaming layer, guarantee the best heat insulation and help shorten the cooling time.
- Equipped with bathtub cover, it further reduces the cooling loss



## CARACTERÍSTICAS FEATURES

MODEL	NDE-20-AIO	NDE-25-AIO
Type	Heating & Cooling	
Water Volume & Chilling Time (from 23°C to 5°C)	50L: ≤0,8h	50L: ≤0,65h
	100L: ≤ 1,65h	100L: ≤1.35h
	200L: ≤ 3,3h	200L: ≤2,7h
	300L: ≤5h	300L: ≤ 4,1h
	500L: ≤83h	500L: ≤6.75h
Heating Water Temp. Range (°C)	15 ~ 40	
Cooling Water Temp. Range (°C)	2 ~ 28	
Operating Ambient Temp. Range (°C)	-5 ~ 43	
Cooling Ambient: 15°C. Water Outlet 2°C		
Cooling Capacity (W)	1510	1600
Power Input (W)	452	476
Current Value (A)	1,97	2,07
EER	3,34	3,36
Heating Ambient: 15°C, Water Inlet 26°C, Humidity: 80%		
Heating Capacity (W)	3180	4200
Power Input (W)	499	664
Current Value (A)	2,17	2,89
COP	6,37	6,33
Power Supply	220-240V ~50hz	
Refrigerant	R32	
Sound Pressure Level at 10m [dB(A)]	32	34
Water Pipe Connection (mm)	Ø1.5	
Water Heat Exchanger	Titanium	
Circulation Pump / Filter / Disinfection	SI/ Paper / Ozone Generator Ozono	
Wire Controller	Pantalla LED	
Net Weight (kg)	185	190
Net Dimensions L x W x H (mm)	489x437x500	



# CLIMATIZACIÓN CLIMATIZATION

## MINI EXCELLENT

Diseño exclusivo para spas y piscinas pequeñas. Se conecta directamente al enchufe de casa, calentando o enfriando el agua en pocas horas.

### CARACTERÍSTICAS

#### Diseño patentado.

La salida y entrada de aire son simétricas para aumentar la eficiencia.

#### Instalación & Funcionalidad simple

Fácil de instalar y conectar. Con un simple control para ajustar la temperatura a la medida de su experiencia. Todo vía WIFI.

#### Bajo Nivel Sonoro

El ruido de la bomba de calor es de tan solo 45 dB(A) a 1 mts de distancia. El bajo nivel sonoro la hace perfecta para el uso residencial.

#### Descongelamiento Inteligente

Equipado con un sistema que le permite de disfrutar de un amplio rango de temperaturas, de -5°C a 43°C. Puede calentar y enfriar el agua a su gusto.

#### Calentamiento y enfriamiento. Tecnología INVERTER

El confort de poder calentar o enfriar el spa a la temperatura que desee.

Exclusive design for spas and small pools. It connects directly to the home socket, heating or cooling the water in a few hours.

### CHARACTERISTICS

#### Patented design.

The air outlet and inlet are symmetrical to increase efficiency.

#### Simple Installation & Functionality

Easy to install and connect. With a simple control to adjust the temperature to suit your experience. All via WIFI.

#### Low Sound Level

The level of noise of the heat pump is only 45 dB(A) at 1 meter away. The low noise level makes it perfect for residential use.

#### Smart Defrost

Equipped with a system that allows you to enjoy a wide range of temperatures, from -5°C to 43°C. You can heat and cool the water as you like.

#### Warming up and cooling down with INVERTER technology

The comfort of being able to heat or cool the spa to the temperature you want.

Heating\*: working condition, Water 26°C, dry bulb temperature 27°C, humidity 80%.

Heating\*\*: working condition, Water 26°C, dry bulb temperature 15°C, humidity 70%.

FEATURES	NDE-04-MEXC	NDE-06-MEXC
Advised pool volume m <sup>3</sup> (with cover)	10-20	15-25
Heating capacity (kW)*	-5 a 43	
Heating*	Heating capacity (kW)	5,5-1,4
	Heating capacity (BUT/h)	18700-4760
	Input power(kW)	1,1-0,8
	COP	5,0-9,6
Heating**	Heating capacity (kW)	3,7-0,8
	Heating capacity (BUT/h)	12580-2720
	Input power(kW)	0,9-0,13
	COP	4,0-6,0
colling* Capacidad(kW)	2,00	3,30
Noise (db(A)) (1m)	<46	<48
Heat exchanger	Titanio con PVC	
Casing	Metal	
Power supply	220-240V/1p/ 50Hz-60HZ	
Diameter of pipe (mm)	Ø 32	
Intensity (A)	2,6-0,4	3,9-0,57
Advised water fux m <sup>3</sup> /h)	1,5-2,0	2,0-2,5
Net weight/Gross weight(kg)	26/28	34/37
Refrigerant/ Consume (gr)	R32/180	R32/380
Compressor	Gree / Inverter / Rotativo	
Valv. 4-ways / Expansion Valv.	Sanhua / Sanhua	
Body size(W*D*H)mm	394X444X435	498*499*500

# CLIMATIZACIÓN CLIMATIZATION

## SERIE ROYAL



**Carcasa de ABS negra**, evitando cualquier corrosión causada por el medio ambiente, dando a la bomba de calor una mayor vida. Con una amplia gama de modelos exteriores.

### CARACTERÍSTICAS

#### Instalación en el exterior

Control WiFi opcional (añadir en cada código -W) Puede parametrizar y controlar el perfecto estado de la temperatura del agua desde cualquier parte del mundo.

#### Alta eficiencia energética

Gracias a su elevado COP de hasta 5,8 a 26°C/23,3°C, obtendrá el mayor rendimiento a muy bajo coste.

#### Descongelación inteligente

La bomba de calor utiliza una válvula de 4 vías para garantizar una automática descongelación incluso a temperaturas ambientes de hasta -7°C.

#### Intercambiador de titanio

La utilización de titanio permite un incremento de hasta un 30% de eficiencia energética en comparación con los intercambiados habituales.

#### Intercambiador hidrofílico

Resistente a la condensación y congelación del agua. Mayor durabilidad gracias a ser anticorrosivo.

#### Compresor

De la marca Toshiba technology GMCC.

**Black plastic ABS casing**, avoiding any corrosion and stain caused by ambient environment and giving your heat pump a longer life time. With a wide range of residential outdoor models.

### CHARACTERISTICS

#### Outdoor installation

Optional WiFi control (add -W to the end of each code) WiFi control gives you the freedom to manage your pool environment regardless of where you are.

#### High energy efficiency

Its COP can go as high as 5,8 at 26°C/23,3°C (DB/WB). Exceptional performance at the lowest cost.

#### Smart defrosting

The heat pump uses the reverse of four-way valve to defrost. It provides an automatic defrosting and allows the heat pump to work under ambient temperature as low as -7°C.

#### Titanium heat exchanger

The twisted titanium coils ensure an increase output up to 30% higher in efficiency compared to the common heat exchanger.

#### Hydrophilic heat exchanger

It is resistant to condensation and freezing. The anticorrosion feature can give a longer lifetime.

#### Compressor

Branded Toshiba technology GMCC.

FEATURES	NDE-P-04	NDE-P-06	NDE-P-09	NDE-P-12	NDE-P-16
Advised pool volume m <sup>3</sup> (with cover)	10-20	15-25	25-35	35-65	60-80
Heating capacity (kW)*	3,90	6,00	8,70	12,00	16,00
Input power (kW)*	0,75	1,05	1,50	2,05	2,70
COP*	5,20	5,71	5,80	5,85	5,93
Heating capacity (kW)**	3,00	4,50	6,50	8'90	11,80
Input power(kW)**	0,70	1,02	1,45	1,98	2,65
COP**	4,29	4,41	4,48	4,49	4,45
Rated Current (A)	3,40	4,60	6,50	9,10	11,50
Noise (db(A))	<42	<44	<45	<47	<50
Net weight/gross(kg)	42/45	45/48	50/54	63/68	72/82
Water connection (mm)	50	50	50	50	50
Body size (W x D x H) (mm)	1008x 380 x 577	1008x 380 x 577	1008x 380 x 577	1008x 380 x 577	1050 x 440x 709
Compressor	Rotary	Rotary	Rotary	Rotary	Rotary
Refrigerant	R410A or R32	R410A or R32	R410A or R32	R410A or R32	R410A or R32
Power supply	w220V/1Ph/50Hz or 60Hz	w220V/1Ph/50Hz or 60Hz	w220V/1Ph/50Hz or 60Hz	w220V/1Ph/50Hz or 60Hz	w220V/1Ph/50Hz or 60Hz
Condenser	Titanium in PVC	Titanium in PVC	Titanium in PVC	Titanium in PVC	Titanium in PVC

Heating\*: Inlet water temperature 26°C, outlet water temperature 28°C, dry bulb temperature 26°C, humidity 80%.

Heating\*\*: Inlet water temperature 26°C, outlet water temperature 28°C, dry bulb temperature 15°C, humidity 70%.



# CLIMATIZACIÓN CLIMATIZATION

## SERIE MASTER

Este tipo de bomba de calor asegura una constante y estable temperatura del agua de su piscina. Con una amplia gama de **modelos INVERTER exterior**. **Carcasa de ABS negra**.

### CARACTERÍSTICAS

#### Instalación en el exterior

Control WiFi opcional (añadir en cada código -W). Puede parametrizar y controlar el perfecto estado de la temperatura del agua desde cualquier parte del mundo.

#### Ahorro de dinero y más eficiencia energética

COP de hasta 13,5 a 26°C/23,3°C (DB/WB). Prácticamente en toda la temporada, la bomba de calor funciona al 50% de capacidad, lo que equivale a un COP de 9, ahorrando un 45% en la factura eléctrica.

#### Calentamiento rápido

Menor tiempo para alcanzar la temperatura de consigna.

#### Temperatura del agua constante

La velocidad es ajustada para mantener la temperatura del agua.

#### Bajo nivel de ruido

Con la tecnología inverter, la bomba de calor funcionará la gran mayoría del tiempo a baja velocidad. El nivel de ruido puede llegar a tan solo 20dB(A) a 10 mts.

#### Múltiples modos de control

Según la demanda se puede escoger diferentes modos: Smart, Silent, Powerful.

*The Inverter Series ensures constant and stable water temperature for your swimming pool. With a wide range of residential outdoor INVERTER models. Black plastic ABS casing.*

### CHARACTERISTICS

#### Outdoor installation

*Optional Wi-Fi control (add -W to the end of each code). Wi-Fi Control gives you the freedom to manage your pool environment regardless of where you are.*

#### More energy efficient and cost saving

*The COP is up to 13,5 at 26°C/23,3aC (DB/WB). During swimming pool season, the heat pump runs at around 50% of its capacity which leads to an average COP of 9. This could reduce the electricity bill by up to 45%.*

#### Fast heating

*It can run at high capacity to heat your swimming pool to the target temperature in a very short time.*

#### Constant water temperature

*It can adjust the speed intelligently and run at low capacity to maintain the pool temperature.*

#### Low noise

*It will run at low speed for most of the time, so the noise level will be low. Under the silent mode, it can even go as far down as 20dB(A) at 10 meters distance.*

#### Multiple control modes

*Users can chose between powerful, smart and silent mode to meet different demands.*



## CARACTERÍSTICAS FEATURES

FEATURES	NDE-06-DC	NDE-09-DC	NDE-12-DC	NDE-16-DC	NDE-20-DC	NDE-25-DC	NDE-30-DC
Advised pool volume m <sup>3</sup> (with cover)	10-25	12-40	15-60	25-85	30-105	40-140	45-170
Heating capacity (kW)*	6.2-2.5	9.3-2.8	12.6-3.2	16.2-3.5	18.6-4.5	24.1-5.9	28.8-6.7
Input power (kW)*	1.09-0.17	1.59-0.21	2.02-0.24	2.56-0.26	3.68-0.35	4.26-0.45	5.09-0.52
COP*	5.69-13.5	5.85-13.3	6.24-13.3	6.11-13.5	5.05-12.9	5.66-13.1	5.66-12.9
Heating capacity (kW)**	4.8-2.3	6.9-2.3	9.5-2.5	11.8-2.7	14.5-4.1	19-5.1	23.4-5.9
Input power (kW)**	1.04-0.32	1.51-0.32	2.05-0.35	2.58-0.38	3.4-0.6	4.4-0.71	5.5-0.83
COP**	4.62-7.14	4.56-7.19	4.63-7.14	4.57-7.11	4.26-6.83	4.32-6.83	4.25-7.11
Rated Current (A)	4.4	6.9	8.5	11.7	16.2	18.7	22.3
Noise (db(A))	<50	<52	<52	<54	<54	<60	<60
Net weight/gross(kg)	42/45	45/48	50/54	63/68	68/73		
Water connection (mm)	50						
Body size (W x D x H) (mm)	1008x 380x 577	1008x 380x 577	1008x 380x 577	1050 x 440 x709	1050 x 440 x709	1050 x 452x1295	1050 x 452x1295
Compressor	Rotary						
Refridgerant	R32						
Power supply	w220V/1Ph/50Hz or 60Hz						
Condenser	Titanium in PVC						

Heating\*: Inlet water temperature 26°C, outlet water temperature 28°C, dry bulb temperature 26°C, humidity 80%.  
 Heating\*\*: Inlet water temperature 26°C, outlet water temperature 28°C, dry bulb temperature 15°C, humidity 70%.



# CLIMATIZACIÓN CLIMATIZATION

## SERIE MASTER PLUS

La nueva **Inverter MASTER PLUS** es una revolucionaria bomba de calor con un diseño único tanto desde dentro como fuera para satisfacer a los clientes más exigentes.

### CARACTERÍSTICAS

#### Diseño exclusivo con carcasa de plástico ABS

La carcasa está hecha de plástico ABS en su totalidad, evitando cualquier corrosión y manchas causadas por un entorno ambiental deficiente.

#### Super Silenciosa

Está especialmente diseñada para reducir al máximo su sonoridad, así podrá descansar durante la noche. Óptima para uso residencial gracias a un nivel sonoro de tan solo 18 dB (A) a una distancia de 10 metros.

*The new MASTER PLUS Inverter is a revolutionary heat pump with a unique design both from inside and outside to satisfy the most demanding customers.*

### CHARACTERISTICS

#### Exclusive design with ABS plastic housing

*The housing is made entirely of ABS plastic, preventing any corrosion and staining caused by poor environmental environment.*

#### Super Silent

*Is specially designed to minimize its noise, so you can rest at night. Optimal for residential use thanks to a sound level of only 18 dB (A) at a distance of 10 meters.*



### Controle su piscina (Wi-Fi)

A través de la aplicación, desde su teléfono podrá controlar la temperatura que desee para que su piscina esté lista para disfrutarla durante todo el año. No importa la temperatura que haya en el exterior.

### Control your pool (Wi-Fi)

*From your Smart phone and connected to the application, you can control the temperature desired for your pool to enjoy it all year round. It doesn't matter what temperature is outside.*





### Calentamiento exponencial

Con un tiempo de calentamiento muy corto, el usuario no tiene que esperar mucho para poder disfrutar de su piscina.

### Exponential heating

*With a very short heating time, the user does not have to wait long to enjoy his pool.*

### Ahorro y eficiencia Energética

COP de hasta 15,0. prácticamente en toda la temporada, la bomba de calor funciona al 50% de capacidad.

### Energy saving and efficiency

*COP up to 15.0 in practically the entire season, the heat pump operates at 50% capacity.*

## CARACTERÍSTICAS FEATURES

PRODUCT MODEL	NDE-08-DCP	NDE-10-DCP	NDE-11-DCP	NDE-14-DCP	NDE-17-DCP	NDE-20-DCP	NDE-24-DCP
Advised pool volume (m <sup>3</sup> )(with cover)	15~30	20~40	25~50	30~60	40~75	55~100	60~140
Heating*							
Heating capacity (kW)	7.50~1.92	9.50~2.10	11.00~2.50	14.00~3.15	17.00~3.75	20.00~4.00	24.00~4.80
Heating capacity (BTU/h)	25500~6528	32300~7140	37400~8500	47600~10710	57800~13090	68000~13600	81600~16320
Input power (kW)	1.15~0.13	1.46~0.14	1.83~0.17	2.15~0.21	2.62~0.25	3.33~0.27	4.00~0.32
COP	6.5~14.8	6.5~15.0	6.0~14.7	6.5~15.0	6.5~15.0	6.0~14.8	6.0~15.0
Heating**							
Heating capacity (kW)	5.80~1.42	7.2~1.50	8.5~1.65	10.7~2.40	13.0~2.65	15.6~2.85	18.7~3.42
Heating capacity (BTU/h)	19720~4828	24480~5100	28900~5610	36380~8160	44200~9010	53040~9690	63580~11630
Input power (kW)	1.15~0.20	1.43~0.21	1.77~0.23	2.12~0.34	2.58~0.36	3.25~0.40	3.89~0.49
COP	5.0~7.1	5.0~7.2	4.8~7.2	5.0~7.1	5.0~7.4	4.8~7.0	4.8~7.0
Rated current(A)	5.1~0.9	6.3~0.9	7.8~1.0	9.3~1.5	11.3~1.6	14.3~1.8	17.8~2.3
Noise (dB(A)) (1m)	38~48	38~48	40~50	42~51	43~52	43~53	44~54
Net weight/Gross weight(kg)	62/70	62/70	64/72	77/87	81/91	81/91	
Diameter of pipe (mm)	Ø50	Ø50	Ø50	Ø50	Ø50	Ø50	Ø50
Metel plate	ABS plastic casing dark grey color						
Body size(W*D*H)mm	1000*396*640					1125*416*765	
Refrigerant	R32						
Power supply	230V/1p/ 50Hz						

Heating\*: working condition, Water 26°C, Air 27°C, Humidity 80%

Heating\*\*: working condition, Water 26°C, Air 15°C, Humidity 70%

# CLIMATIZACIÓN CLIMATIZATION

## Serie EXCELLENT

### Tecnología INVERTER

- Trabaja a temperaturas muy bajas -15°C.
- Control de temperatura preciso -0,5°C. Permite ajustar la potencia entre 10% y un 90%, reduciendo hasta un 50% el consumo energético.
- Con un COP de hasta 16,2 (temp. agua 26°C, temp. aire 26°C, humedad 80%)

### Control remoto vía APP

Pantalla de LCD + conexión WIFI

### Ultra silenciosa.

Tan solo 18 dB(A) a 10m distancia. Gracias a su compresor rotativo y a su diseño exclusivo.

## CARACTERÍSTICAS FEATURES



Precise temperature control -0.5°C  
Quick defrosting  
LCD screen + WIFI connection  
High COP, top blowing.

Heating\*: working condition, Water 26°C, Air 27°C, Humidity 80%  
Heating\*\*: working condition, Water 26°C, Air 15°C, Humidity 70%  
Cooling\*\*\*: Water 28°C, Air 35°C, Humidity 80%

PRODUCT MODEL	NDE-HDS14-EX	NDE-HDS17-EX	NDE-HDS21-EX	NDE-HDS24-EX	INDE-HDS28-EX	NDE-HDS28T-EX	NDE-HDS32T-EX
Advised pool volume (m³)(with cover)	25-50	30-60	40-75	50-90	60-100	60-100	70-120
Temperatura de trabajo (°C)	-15 a 43						
Heating*							
Heating capacity (kW)	14,0-3,20	17,50-3,50	21,5-5,00	24,50-5,50	28,50-7,00	28,50-7,00	32,50-7,5
Heating capacity (BTU/h)	47600-10880	59500-11900	73100-1700	83300-18700	96900-23800	96900-23800	110200-25500
Input power (kW)	1,94-0,20	2,50-0,2	3,10-0,31	3,65-0,34	4,20-0,44	4,20-0,44	5,00-0,48
COP	7,2-16,0	7,0-15,9	6,9-16,1	6,7-16,2	6,8-15,9	6,8-15,9	6,5-15,6
Heating**							
Heating capacity (kW)	10,51-2,48	13,0-2,57	16,25-3,60	19,10-4,2	22,5-5,0	22,5-5,0	25,5-5,5
Heating capacity (BTU/h)	35734-8432	44200-8738	55250-12240	64940-14280	76500-1700	76500-1700	87720-18700
Input power (kW)	1.15~0.20	1.43~0.21	1.77~0.23	2.12~0.34	2.58~0.36	3.25~0.40	3.89~0.49
COP	5,5-8,0	5,4-8,0	5,3-8,0	5,4-7,9	5,4-8,1	5,4-8,1	5,2-8,0
Cooling*** Capacidad (KW)	9,2	11,5	13,8	15,7	18,4	18,4	20,7
Noise dB(A) (1m)	40-49	40-50	42-51	43-52	43-53	43-53	43-54
Noise dB(A) 10m	18,5-27	45	45	46	46,5	46,5	47
Heat exchanger	8,4-1,4	22,0-27,5	22,5-29,5	23-30	23,5-31	23,5-31	24-32
Casing	Metal						
Power supply	220-240V / 1 Fs				380-400V/3Fs		
Diameter of pipe (mm)	Ø50						
Intensity (A)	8,4-1,4	10,5-1,4	13,3-2,0	15,5-2,3	18,3-2,7	6,4-1,0	7,5-1,1
Advised water flux(m³/H)	4-6	6-8	7-9	8-10	9-11	9-11	10-12
Water Pressure Drop (max) kPa	4	5	7	10	13	13	15
Net weight/Gross weight(kg)	80/95	100/115	150/170	160/170	220/250	230/260	230/260
Body size(W*D*H)mm	719X708X768		767X824X867			916*904*922	
Refrigerant	R32						
Compressor	Panasonic						

# CLIMATIZACIÓN CLIMATIZATION

## SERIE COMERCIAL SALIDA SUPERIOR TOP DISCHARGE



Bombas de calor comerciales con salida superior para trabajar en el exterior.

- Estructura principal y paneles externos son de chapa galvanizada o **acero inoxidable 304-316L opcional**.
- Panel de control LCD.
- Aislamiento térmico interno para aumentar el COP.
- **Opcional evaporizador anticorrosivo.**
- Ventilador exterior axial para garantiza un menor ruido y vibración.
- Serpentín de cobre de alta calidad construido con tecnología de rosca exterior.
- Función de descongelación automática incluida.
- Todas las unidades testadas antes de salir de fábrica.

Comercial heat pump with top discharge prepared to work outdoor.

- Base frame and externa) panels are made of galvanized sheet or **stainless steel 304-316L optional**.
- Touch design LCD control panel.
- Well heat insulation inside the unit to increase the COP.
- **Optional evaporator anti-corrosive.**
- Exterior rotor fan ensures lower noise and vibration.
- High quality copper tube coils constructed of outer thread technology
- Automatic defrosting function included
- General testing and operational test carried out for every unit before packaging in the factory.

FEATURES	NDE-PF-30	NDE-PF-50	NDE-PF-100	NDE-PF-120	NDE-PF-150	NDE-PF-200	NDE-PF-250	NDE-PF-300
Heating capacity (kW)*	16.00	25.00	49.50	57.90	68.50	99.70	118.60	140.60
Input power (kW)*	2.70	4.20	8.50	9.80	11.80	17.00	20.50	24.10
COP*	5.93	5.95	5.82	5.91	5.81	5.86	5.79	5.83
Heating capacity (kW)**	11.80	17.50	38.30	43.50	51.30	73.80	86.20	101.30
Input power(kW)**	2.65	3.90	8.30	9.40	11.20	16.20	18.90	22.30
COP**	4.45	4.49	4.61	4.63	4.58	4.56	4.56	4.54
Rated Current (A)	6.90	10.80	21.30	24.90	29.50	42.90	51.00	60.50
Noise (db(A))	<55	<58	<66	<66	<68	<68	<72	<75
Net weight/gross(kg)	100/106	145/155	300/320	330/350	372/412	482/532	582/642	612/675
Water connection (mm)	50ø		63ø		75ø		90ø	
Body size (W x D x H) (mm)	710x 710x 870	810x 800x 1300	1580x 800x 1600			1850x 1000x 1950	2000x 1100x 2080	2300x 1100x 2300
Compressor	Scroll / Copeland							
Refrigerant	R410A				R407C			
Power supply	220V/1Ph/50Hz or 60Hz				380V/3Ph/50Hz or 60Hz			
Condenser	Titanium in PVC							
Evaporator	U-1/ 1660*650 ø9.52	U-1/ 1860*900 ø9.52 60*900ø9.52	V-2/ 652*1260*2 ø9.52	V-3/ 652*1260*2 ø9.52	V-3/ 652*1260*2 ø9.52	V-3/ 900*1500*2 ø9.52	V-3/ 900*1700*2 ø9.52	V-3/ 900*1900*2 ø9.52
Four Way Valve	DSF-11		DSF-20			DSF-35		
Expansion Valve	Sanhua/Emmerson							
Ac Contactor	220V-18A	220V-25A	(220V-18A)*2	(220V-125A)*2	(220V-32A)*2	(220V-38A)*2		
Controller	Dual System (Motorolla Chip)							
Low voltage Switch	0.05/0.25 Mpa							
High voltage Switch	3.0/ 3.6 Mpa							
Power cable connector with unit	3*4mm <sup>2</sup>	3*4mm <sup>2</sup> + 2*2.5 mm <sup>2</sup>	3*6mm <sup>2</sup> + 2*2.5 mm <sup>2</sup>		3*10mm <sup>2</sup> + 2*4mm <sup>2</sup>		3*16mm <sup>2</sup> + 2*6mm <sup>2</sup>	
Packing	Plywood							

Heating\*: Inlet water temperature 26°C, outlet water temperature 28°C, dry bulb temperature 26°C, humidity 80%.

Heating\*\*: Inlet water temperature 26°C, outlet water temperature 28°C, dry bulb temperature 15°C, humidity 70%.

# CLIMATIZACIÓN CLIMATIZATION

## SERIE COMERCIAL SALIDA LATERAL SIDE DISCHARGE

La Serie Comercial le acerca a la máxima eficiencia. Absorbe hasta 6 veces el calor del aire y lo transfiere a la piscina, lo que hace que el calentamiento sea un proceso ecológico y de ahorro. Con salida lateral para trabajar en exterior.

### CARACTERÍSTICAS

#### Ultra eficiente

Con un intercambiador de titanio Premium, es capaz de asegurar un flujo hidráulico superior para una excelente eficiencia y ahorro energético.

#### Función cuatro estaciones

Puede trabajar en una amplia gama de temperaturas que van desde -7°C hasta los 43°C, suministrándole agua caliente durante todo el año.

#### Silenciosa

Bajo nivel de ruido gracias a la espuma integrada interiormente y a su diseño.

#### Fiabilidad

La alta calidad del intercambiador de calor de titanio le garantiza un calentamiento incluso con cloro, sal o tratamientos de bromo.

#### Sistema inteligente de descongelación

Con la válvula de 4 vías, combinado con el sistema inteligente de auto-descongelación, le asegura un funcionamiento eficiente incluso en condiciones de frío extremas.

#### Fiabilidad

Gracias a sus componentes de máxima calidad, el funcionamiento será estable durante todo el tiempo. Sistema de aislamiento tanto eléctrico como de agua para garantizar un uso diario.

*The Commercial Series provide the maximum energy efficiency and reliability. It absorbs another 6 times of free heat from the ambient environment and transfers it to the pool water, which makes the heating process ecological and cost saving. With side discharge for outdoor use.*

### CHARACTERISTICS

#### Ultra efficiency

*With enlarged evaporator and Premium titanium heat exchanger, the heat pump provides a superior hydraulic flow for excellent efficiency and maximum energy savings.*

#### Four season function

*Can work under wide ambient temperature ranges, from -7°C to 43aC, and provides all year round warm water.*

#### Quiet operation

*With the superior low noise, plus the inner sound absorbant foam, it runs at very low noise.*

#### Reliability

*High quality titanium heat exchanges garantees that the heat pump can heat the pool water after chlorine, salt and bromine treatment.*

#### Intelligent defrosting system

*With its high quality 4 way valve, combined with an intelligent auto-defrosting system, it ensures the heat pump can work smoothly under severe cold environment.*

#### Security and stability

*Well selected top brand components provide the most stable performance. Totally isolated electricity and water systems to guarantee a secure daily use.*

## CARACTERÍSTICAS FEATURES



FEATURES	NDE-P-16-HS	NDE-P-21-HS	NDE-P-25-HS	NDE-P-30-HS
Advised pool volume m <sup>3</sup> (with cover)	60-80	70-90	80-100	100-120
Heating capacity (kW)*	16,00	21,00	25,00	30,00
Input power (kW)*	2,70	3,58	4,20	4,80
COP*	5,93	5,87	4,95	6,25
Heating capacity (kW)**	11.80	15.00	17.50	22.50
Input power(kW)**	2.65	3.35	3.90	4.70
COP**	4.45	4.48	4.49	4.79
Rated Current (A)	11.7	15.5	7.50	8.50
Noise (db(A))	<50	<50	<58	<52
Net weight/gross(kg)	100/106	102/112	105/115	135/150
Water connection (mm)	50			
Body size (W x D x H) (mm)	710x 710 x 870	1110x 490 x 1260	1110x 490 x 1260	1110x 490 x 1260
Compressor	Scroll			
Refridgerant	R410A			
Power supply	w220V/1Ph/50Hz or 60Hz		w220V/3Ph/50Hz or 60Hz	
Condenser	Titanium in PVC			
Four Way Valve	SHF-7H-34U	DSF-20	DSF-20	DSF-20
Motor (capacity)	90W*1(5uf)	90W*2(5uf)	90W*2(5uf)	90W*2(5uf)
Fan	Ø 490*1	Ø 490*2	Ø 490*2	Ø 490*2
Controller	Single System (Motorola chip)			
High voltage switch	3.0 / 3.6 Mpa			
Power cable connector with unit	3*2,5 mm <sup>2</sup>	3*4 mm <sup>2</sup>	3*2,5 mm <sup>2</sup> + 3*1,5 mm <sup>2</sup>	3*4 mm <sup>2</sup> + 2*2,5 mm <sup>2</sup>

Heating\*: Inlet water temperature 26°C, outlet water temperature 28°C, dry bulb temperature 26°C, humidity 80%.

Heating\*\*: Inlet water temperature 26°C, outlet water temperature 28°C, dry bulb temperature 15°C, humidity 70%.







# BOMBAS DE CALOR INVERTER DE HOGAR

## INVERTER HOUSE HEAT PUMP



La serie Inverter PREMIUM es una unidad multifuncional de calefacción, refrigeración y ACS. Combina de forma creativa el refrigerante R32 respetuoso con el medio ambiente con tecnología Inverter, con etiqueta A+++ , que puede funcionar de manera estable en áreas extremadamente frías de hasta -30°C estructura principal y paneles externos son de chapa galvanizada o **acero inoxidable 304-316L opcional**.

Panel de control LCD a color, función wifi y control de temperatura preciso de  $\pm 0,1^{\circ}\text{C}$  para brindar la mejor experiencia de hogar.

The Inverter PREMIUM series is a multifunctional heating, cooling and DHW unit. It creatively combines environmentally friendly R32 refrigerant with Inverter technology, labeled A+++ , which can work stably in extremely cold areas down to minus 30°C.

Color LCD control panel, wifi function and  $\pm 0.1^{\circ}\text{C}$  precise temperature control to provide the best home experience.

PREMIUM INVERTER	NDE-09-CFC	NDE-13-CFC	NDE-18-CFC	NDE-23-CFC	NDE-28-CFC	NDE-35-CFC
<b>Heating conditions:</b> Amb. Temp. (DB/WB): 7°C/6°C, Water Temp. (in/out): 30°C/35°C						
Capacity (kW)	1,57-8,40	4,40-13,00	5,9-18,2	7,5-23,0	10,2-28,0	12,8-35,0
Power Input Range (kW)	0,32-1,87	0,90-3,02	1,20-4,11	1,53-5,23	2,07-6,36	2,61-7,99
Current Range (A)	1,42-8,30	1,39-4,68/4,12-13,8	1,86-6,37/5,49-18,8	2,37-8,11	3,70-11,4	4,67-14,3
COP (kW)	4,49-4,91	4,30-4,90	4,43-4,92	4,40-4,90	4,40-4,92	4,38-4,90
<b>Cooling conditions:</b> Amb. Temp. (DB/WB): 12°C/7°C, Water Temp. (in/out): 35°C/24°C						
Capacity (kW)	0,99-6,22	2,80-8,20	3,81-11,53	4,73-14,6	6,54-19,8	8,13-24,6
Power Input Range (kW)	0,29-2,18	0,85-3,31	1,11-4,05	1,39-5,14	1,92-6,97	2,42-8,75
Current Range (A)	1,28-9,67	1,32-5,13/3,89-15,1	1,72-6,28/5,08-18,5	2,16-7,97	3,43-12,5	4,33-15,6
COP (kW)	2,85-3,41	2,48-3,29	2,85-3,43	2,84-3,40	2,84-3,40	2,81-3,36
<b>DHW conditions:</b> Amb. Temp. (DB/WB): 7°C/6°C, Water Temp. (in/out): 15°C/55°C						
Capacity (kW)	1,28-6,81	3,52-10,50	4,80-14,72	6,1-18,5	12,3-20,4	13,6-22,6
Power Input Range (kW)	0,31-2,13	0,88-3,39	1,17-4,60	1,53-5,97	2,8-5,37	3,09-5,95
Current Range (A)	1,38-9,45	1,36-5,26/4,03-15,5	1,82-7,15/5,35-21,1	2,37-9,26	5,0-9,6	5,52-10,6
COP (kW)	3,2-4,1	3,1-4,0	3,2-4,1	3,1-4,0	3,8-4,4	3,8-4,4
ErP level (35°C)	A+++	A+++	A+++	A+++	A+++	A+++
ErP level (55°C)	A++	A++	A++	A++	A++	A++
Refrigerant	R32					
Power supply	230V/1Ph/50Hz	230V/1Ph/50Hz o 380-400V/3Ph/50Hz		380-400V/3Ph/50Hz		
Working area (°C)	-30 a 43					
Water circulation(m³/h)	1,4	2,2	3,1	4	4,8	6
Water pressure drop (Kpa)	31	25	35	45	40	50
IP Grade (Level of protection) (V/Hz)	IPX4					
Noise(dB(A))	<53	<55	<57	<58	<62	<66
Casing	Galvanized steel					
Net weight / Gross weight (kg)	110/120	140/150	170/180	180/190	210/220	230/240
Diamter of pipe(mm)	DN25	DN25	DN25	DN25	DN32	DN32
Body size (W*D*H)(mm)	970*475*835	1100*475*985	1050*480*1330	1050*480*1330	1160*500*1580	1160*500*1580
Operating water temp. heating (°C)	20 a 55					
Operating water temp. DWS (°C)	20 a 55					
Operating water temp. Cooling (°C)	7 a 35					

ACCESORIOS DE LIMPIEZA  
CLEANING ACCESSORIES

# Cepillo AUTOMÁTICO Lineo

## AUTOMATIC Brush Lineo

Una solución automática para todo tipo de suelos

- Para todo tipos de suelos y paredes
- Batería incorporada
- Pértiga telescópica desde 1.50m a 2.50m
- Cabezal regulable 70°
- Sumergible hasta 15m
- Limpia, abrillanta y pule.
- Perfecto para la línea de flotación, duchas, vestuarios, gimnasios...



Automatic solution for all type of floors and walls

- Suitable for any type of surface
- Include battery
- Telescopic pole from 1.50m to 2.50m
- Adjustable head 70°
- Can even submerged up to 15cm
- Clean and polish.
- Perfect for the waterline, showers, locker rooms, gyms...



Cepillos

Soporte almohadilla



Almohadilla



Cargador de batería para serie M

Cargador 220V / 12V DC

Código	NDE-LHCM	NDE-LHCXL
Medida cepillo	ø 15 cm	ø 22 cm
Alimentación	12V battery	24V batería litio
Pértiga telescópico	150 to 250 cm	250 to 500 cm
Potencia / Autonomía	40 W / 1h30'	>1h to 2h
Peso	2,5 kg	4 kg
Cepillo / Limpieza	Almohadilla / nylon rotativo a 70°	Nylon rotativo (cepillo opcional)
Dimensiones (LxAxH-doblado)	17 x 112 x 15 cm	

# LIMPIAFONDOS ELÉCTRICOS COMERCIALES - GAMA PROFESIONAL

## AUTOMATIC COMMERCIAL POOL CLEANERS - PROFESSIONAL SERIES

LINEA PREMIUM PREMIUM LINE NDE-ATLAS

Características/Technical features	ATLAS- M	ATLAS-L	ATLAS-XL
			
Modo/Mode	Suelo/Floor	Suelo/Floor	Suelo/Floor
Longitud piscina/Pool length	hasta 25 m / Up to 25 m	hasta 60 m / Up to 60 m	hasta 75 m / Up to 75 m
Ancho Robot/Cleaner width	50 cm	60 cm	70 cm
Velocidad limpieza/Cleaning speed	10 a/to 18 m/min	10 a/to 18 m/min	10 a/to 18 m/min
Potencia de aspiración/Suction power	50 m <sup>3</sup> /h	50 m <sup>3</sup> /h	50 m <sup>3</sup> /h
Peso fuera-dentro del agua/Weight out-in water	22 kg / 3 Kg	23 kg / 3 Kg	24 kg / 3 Kg
Carro acero inox./Stainless steel Trolley	Con/With	Con/With	Con/With
Mando distancia/Remote control	Con/With	Con/With	Con/With
Capacidad filtración/Filtration capacity	3,1 kg	3,1 kg	3,1 kg
IR (detección paredes)/IR (detection walls)	2 or 4	2 or 4	2 or 4
Alimentación/Power supply	110 v-240 v / 24 vdc	110 v-240 v / 24 vdc	110 v-240 v / 24 vdc

Dimensiones/Dimensions

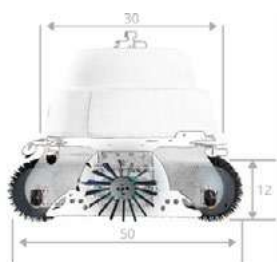

Cepillo lateral/Lateral brushes

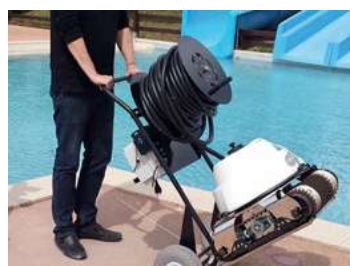





# OPCIONALES/OPTIONS





## MODOS AUTOMÁTICOS DE LIMPIEZA / AUTO CLEANING MODES

Ultra rápido/ <i>Ultra fast</i>	Confort/ <i>Confort</i>	Magellan	En V/ <i>V shape</i>	Pared&Suelo/ <i>Floor&amp;Walls</i>
10' para/ <i>for 25m</i>	45' para/ <i>for 25m</i>	1h15' para/ <i>for 25m</i>	2h30' para/ <i>for 25m</i>	3h30' para/ <i>for 25m</i>
30' para/ <i>for 50m</i>	1h30' para/ <i>for 50m</i>	3h para/ <i>for 50m</i>	5h para/ <i>for 50m</i>	6h para/ <i>for 50m</i>
				

## MANGUERA / CABLE

25 m	32 m	40 m	50 m
PVC Reforzado/ <i>Reinforced PVC</i>	PVC Reforzado/ <i>Reinforced PVC</i>	PVC Reforzado/ <i>Reinforced PVC</i>	PVC Reforzado/ <i>Reinforced PVC</i>
			

## CARROS / TROLLEYS

Simple	25-32 m Bobina/ <i>Reel</i>	40-50 m Bobina/ <i>Reel</i>	Con gancho/ <i>With winch</i>
			



## CÁMARA / CAMERA

Cámara sumergible IP68 con 8 leds/*Waterproof camera IP68 with 8 leds*

## FILTROS/FILTERS

20 µm	Muy fino/ <i>Very fine</i>	Alga, hongos, diatomeas/ <i>Algae, fungusses, diatom</i>	
75 µm	Fino/ <i>Fine</i>	Arena, algas/ <i>Sand, algae</i>	
105 µm	Estandar/ <i>Standard</i>	Arena, pelos, yeso/ <i>Sand, hair, plaster</i>	
250 µm	Para exteriores/ <i>For Exteriors</i>	Hojas, grava/ <i>Leaves, gravel</i>	
1000 µm	Inicio temporada/ <i>Start season</i>	Hojas, grava/ <i>Leaves, gravel</i>	
2000 µm	Inicio temporada/ <i>Start season</i>	Escombros, piedras/ <i>Debris, stones</i>	
Separado hojas/ <i>Leaves plate</i>	1 cm		
TOP 1	Extra filtración, bolsa/ <i>Extra filtration, bag</i>	Adaptable a cualquier filtro/ <i>Adaptable to all filter</i>	

## CEPILLOS/BRUSHES

PVC	MIXTO/MIXED	PVA
Suelos liner/ <i>Liner floors</i>	Suelos standard/ <i>Standard floors</i>	Suelos mosaico(resbaladizos)/ <i>Tiles floors (slippery)</i>
		

## ACCESORIOS/ACCESSORIES

ALIMENTACIÓN REMOTA/ <i>REMOTE POWER SUPPLY</i>	KIT GRAN PROFUNDIDAD/ <i>GREAT DEPTH KIT</i>
KIT ELEVADOR/ <i>RE-LIFT KIT</i>	KIT AGUA SALADA/ <i>SALTWATER KIT</i>
Para piscinas c/boquillas suelo/ <i>For bottom inlets pools</i>	KIT LINER/ <i>LINER KIT</i>
CUBIERTA PROTECTORA/ <i>PROTECTIVE COVER</i>	

# ACCESORIOS DE LIMPIEZA CLEANING ACCESSORIES



Code	DESCRIPTION
LC90020	Cepillo pared PVC, resistente UV (10"-26cm) <i>Wall brush PVC, UV-proof (10"-26cm)</i>



Code	DESCRIPTION
LC90021	Cepillo curvado PVC, resistente UV (18"-45cm) <i>Wall curved brush PVC, UV-proof (10"-26cm)</i>



Code	DESCRIPTION
LC90022	Cepillo algas acero inoxidable (10"-26cm) <i>Stainless steel algae brush (10"-26cm)</i>



Code	DESCRIPTION
LC90023	Cepillo curvado con aluminio pintado negro (18"-45cm) <i>Wall brush with painted aluminium black (18"-45cm)</i>



Code	DESCRIPTION
LC90030	Recogehojas plano <i>Leaf skimmer flat</i>



Code	DESCRIPTION
LC90031	Recogehojas reforzado <i>Reinforced shallow Leaf skimmer</i>



Code	DESCRIPTION
LC90032	Recogehojas bolsa <i>Deep rake bag skimmer</i>



Code	DESCRIPTION
LC90033	Recogehojas bolsa reforzado <i>Reinforced Deep rake bag skimmer</i>

# ACCESORIOS DE LIMPIEZA CLEANING ACCESSORIES



Code	DESCRIPTION
------	-------------

LC90040 Aspirador PVC triangular  
*Triangle PVC vacuum head with swivel*



Code	DESCRIPTION
------	-------------

LC90041 Aspirador transparente de Lujo triangular  
*Deluxe Transparent cast iron weighted vacuum head*

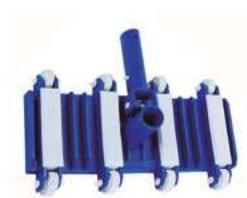

Code	DESCRIPTION
------	-------------

LC90042 Aspirador flexible para piscinas enterradas (14")  
*Flexible vacuum head for in-ground pool (14")*



Code	DESCRIPTION
------	-------------

LC90043 Aspirador flexible con cepillo lateral para piscinas enterradas  
*Flexible vacuum head with side brush for in-ground pool*



Code	DESCRIPTION
------	-------------

LC90044 Aspirador de lujo para liner  
*Deluxe liner vacuum (cast iron weighted)*



Code	DESCRIPTION
------	-------------

LC90045 Aspirador de lujo con cepillo lateral para liner  
*Deluxe liner vacuum with side brush (cast iron weighted)*



# ACCESORIOS DE LIMPIEZA CLEANING ACCESSORIES



Code	DESCRIPTION
LC90050	Pértiga telescópica Azul (2 x 120cm) <i>Telescopic Blue pole (2 x 120cm)</i>
LC90051	Pértiga telescópica Azul (2 x 180cm) <i>Telescopic Blue pole (2 x 180cm)</i>
LC90052	Pértiga telescópica Azul (2 x 240cm) <i>Telescopic Blue pole (2 x 240cm)</i>



Code	DESCRIPTION
LC90060	Manguera aspiración Azul (9m) <i>Vacuum hose (9m)</i>
LC90061	Manguera aspiración Azul (11m) <i>Vacuum hose (11m)</i>
LC90062	Manguera aspiración Azul (13m) <i>Vacuum hose (13m)</i>
LC90063	Manguera aspiración Azul (15m) <i>Vacuum hose (15m)</i>
LC90064	Manguera aspiración Azul (30m) <i>Vacuum hose (30m)</i>



Code	DESCRIPTION
LC90070	Dispensador flotante de lujo (5") <i>Deluxe chemical dispenser (5")</i>
LC90071	Dispensador flotante de lujo (7") <i>Deluxe chemical dispenser (7")</i>
LC90072	Dispensador flotante de lujo (9") <i>Deluxe chemical dispenser (9")</i>



Code	DESCRIPTION
LC90080	Termómetro flotante de lujo con enganche <i>Deluxe floating thermoteter with string attachment</i>
LC90081	Termómetro animal flotante de 4 tipos <i>Deluxe floating animal thermoteter in 4 styles</i>

## EQUIPAMIENTO Y ACCESORIOS

Suministramos y distribuimos todo aquello relacionado con equipamientos para la natación de piscinas públicas, residenciales, comunitarias y de competición. Pida nuestro catálogo completo.

## EQUIPMENT AND ACCESSORIES

*We supply and distribute everything related to swimming equipment for public, residential, community, and competition pools. Please ask for our complete catalogue.*



## MATERIAL DE COMPETICIÓN COMPETITION EQUIPMENT

# EQUIPAMIENTO EQUIPMENT



Code	DESCRIPTION
PO15225C (25m)	Línea de flotación Mod. Gran Moscú c/cable inox.
PO15250C (50m)	Flotation line Mod. Gran Moscú w/ss cable

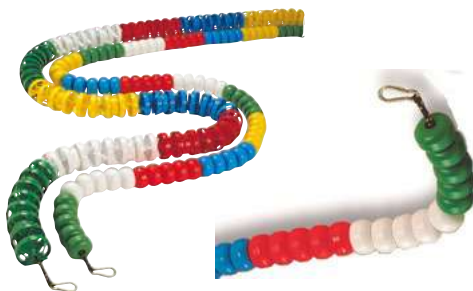

Code	DESCRIPTION
PO15125 (25m)	Línea de flotación Mod.Moscú c/cuerda
PO15150 (50m)	Flotation line Mod.Moscú w/rope
PO15025 (25m)	Línea de flotación Mod.Roma c/cuerda
PO15050 (50m)	Flotation line Mod.Roma w/rope



Code	DESCRIPTION
PO16380 1,8m	Enrollador area flotación
PO16320 1,2m	Water line roller



Code	DESCRIPTION
PO16100	Tensor de rosca para cuerda Thread tensioner for rope



Code	DESCRIPTION
PO15350-50m	Cable acero inox. Ø 3mm
PO15325-25m	SS Cable Ø 3mm



Code	DESCRIPTION
PO15400	Cuerda línea flotación ml Flotation line rope ml



Code	DESCRIPTION
PO16501	Anclaje 1 alojamiento Anchor with 1 lodging



Code	DESCRIPTION
PO16502	Anclaje 2 alojamientos Anchor with 2 lodgings



Code	DESCRIPTION
PO16503	Anclaje 3 alojamientos Anchor with 3 lodgings



Code	DESCRIPTION
PO16601 (300mm)	Soporte placa de giro
PO16602 (185mm)	Turning plate bracket



Code	DESCRIPTION
PO16404	Anclaje con cadena Anchor with chain



Code	DESCRIPTION
PO16000 Blue	Tensor especial cable
PO16001 Red	Cable tensionerr

# EQUIPAMIENTO EQUIPMENT



Code	DESCRIPTION
PO16200	Muelle estabilizador acero inox. electropulido <i>SS. Electropolish stabilizing spring</i>



Code	DESCRIPTION
PO16400	Anclaje tintero con tapa acero inox. <i>SS. Lid with anchorage</i>



Code	DESCRIPTION
PO16401	Soporte bayoneta Ø43mm <i>Bayonet bracket Ø43 mm</i>



Code	DESCRIPTION
PO16402 PO16402-F (inclined)	Anclaje bayoneta acero inox. Ø43 mm <i>SS. Bayonet anchorage Ø43 mm</i>



Code	DESCRIPTION
PO16403	Anclaje tipo copa acero inox. Ø43 mm <i>SS. Cup anchorage Ø43 mm</i>



Code	DESCRIPTION
PO16404	Anclaje con cadena acero inox. Ø30 mm <i>SS. Anchorage with chain Ø30 mm</i>



Code	DESCRIPTION
PO16501	Anclaje 1 alojamiento acero inox. Ø30 mm <i>SS. Anchorage 1 lodging Ø30 mm</i>



Code	DESCRIPTION
PO16504	Anclaje sargento acero inox. <i>SS. Sargento anchorage</i>



Code	DESCRIPTION
PO16600	Anclaje tipo caja acero inox. <i>SS. Anchorage box style</i>



Code	DESCRIPTION
PO16700	Anclaje rosca acero inox. <i>SS. Threaded anchorage</i>



Code	DESCRIPTION
PO17400R 50x50x40 cm PO17500R 50x50x50 cm	Podium salida columna redonda acero inox. <i>SS. Starting block round column</i>



Code	DESCRIPTION
PO17400C 50x50x40 cm PO17500C 50x50x50 cm	Podium salida columna cuadrada acero inox. <i>SS. Starting block square column</i>

# EQUIPAMIENTO EQUIPMENT



Code	DESCRIPTION
PO17700 Altura 70cm Height 70cm	Podium salida con peldaño acero inox. SS. Starting block step



Code	DESCRIPTION
PO17800F Competition	Podium 7 posiciones FINA Starting block 7 positions FINA



Code	DESCRIPTION
PO17801F Competition	Podium 7 posiciones FINA Starting block 7 positions FINA



PO17100 - 200x30 cm  
PO17101 - 200 x 18,5 cm  
PO17103 - 250x30 cm  
PO17102 - 250 x 18,5 cm

Code	DESCRIPTION
PO17100 (varios)	Placa giro acero inox. 316 + PVC. SS.316 turning plate



PO17200 - 200 x 18,5 cm  
PO17201 - 200 x 30 cm  
PO17202 - 250 x 30 cm  
PO17203 - 250 x 18,5 cm

Code	DESCRIPTION
PO17200 (varios)	Placa giro acero inox. 316 + plástico SS.316 + PVC Turning plate



Code	DESCRIPTION
PO17300	Sistema cronometraje touchpad Chrono competition system touchpad



PO17012SF -1,8/12,5m  
PO17016SF -1,8/16,66m  
PO17021SF -1,8/21m  
PO17025SF -1,8/25m

Code	DESCRIPTION
PO17002SF (varios)	Poste + gallardetes salida falsa completo Complete marking fullback poles + pennants



PO17012ESP -1,8/12,5m  
PO17016ESP -1,8 /16,66m  
PO17021ESP -1,8 /21m  
PO17025ESP -1,8 /25m

Code	DESCRIPTION
PO17012ESP (varios)	Poste + gallardetes plástico salida falsa completo Complete marking fullback poles + plastic pennants



Code	DESCRIPTION
PO1700PE	Plataforma elevada Elevated platform



Code	DESCRIPTION
PO1700PM	Puente móvil manual o motorizado Manual or motorised mobile



Code	DESCRIPTION
POELK2-150	Elevador hidráulico fijo hasta 150kg Fix hydraulic elevator up to 150 kg
POELPK2-150	Elevador hidráulico portatial hasta 150kg Portable hydraulic elevator up to 150 kg



Code	DESCRIPTION
POGRUA	Elevador grúa portatil. (diferentes modelos) Consultar. Portable Crane lift (different models). Ask for.

# ENTRENAMIENTO TRAINING



Code	DESCRIPTION
PORC400 80x80 cm	Cronómetro 4 agujas <i>Chronometer 4 hands</i>



Code	DESCRIPTION
PORC460 (60 cm) PORC480 (80 cm)	4 agujas caja acero inox. + protección metrarrilato <i>4 hands ss. Box + metraquilate protection</i>



Code	DESCRIPTION
PO96030	Silbato <i>Whistle</i>



Code	DESCRIPTION
PORCV10	Cuenta vueltas <i>Lap counter</i>



Code	DESCRIPTION
POWP100	Saque central PW competición <i>Kickoff WP competition</i>



Code	DESCRIPTION
POWP3000 316x112x155cm	Portería waterpolo <i>Waterpolo goal</i>



Code	DESCRIPTION
POWP30	Balón waterpolo <i>Ball water polo</i>



Code	DESCRIPTION
POWP1R - 1 u. POWP26SET - 26 u. POWP28SET - 28 u. POWP30SET - 30 u.	Gorros water polo Azul/Blanco/Rojo <i>Waterpolo caps Blue/White/red</i>



Code	DESCRIPTION
PO11100	Gorro personalizado <i>Customized hat</i>



Code	DESCRIPTION
PO10801	NDE - Bike 1



Code	DESCRIPTION
PO10802	NDE - Bike 2



Code	DESCRIPTION
PO10803	NDE - Bike 3

SOS SOS



Code	DESCRIPTION
PO20201	Lifeguard Roller



Code	DESCRIPTION
PO20200	Floty foam



Code	DESCRIPTION
PO20500	Maniquí de socorrismo Lifesaving dummy



Code	DESCRIPTION
PO20702	Collar inmovilizador espuma recubierta Immobilising collar, covered foam



Code	DESCRIPTION
PO20800	Bolsa equipo resucitación completo Compete resuscitation bag



Code	DESCRIPTION
PO20801	Maletín plástico Plastic case



Code	DESCRIPTION
PO20803	Botiquín armario c/llave metálico Metal medical cabinet w/key



Code	DESCRIPTION
PO20700	Tablero espinal, arnés incluido Spinal board, harness included



Code	DESCRIPTION
PO20703	Camilla exploración y masaje portátil Portable exploration & massage stretcher



Code	DESCRIPTION
PO20704	Camilla exploración Exploration stretcher



Code	DESCRIPTION
PO20705	Resucitador adultos Adult resuscitator



Code	DESCRIPTION
PO20600	Silla con ruedas anfibia Amphibious handicapped chair

# SOS SOS



Inox 150 cm  
Stainless steel 150 cm

Code	DESCRIPTION
PO20000   Int. Ø45 - Ext.Ø70	Aro salvavidas lona <i>Lifesaving ring canvas</i>
PO20001   Int. Ø47 - Ext.Ø75	Aro salvavidas plástico <i>PVC Lifesaving ring</i>

Code	DESCRIPTION
PO20103 Ø 43 h 150 m	Soporte aro salvavidas de pie acero inox. <i>SS. Lifesaving ring holder standing</i>



Inox  
Stainless steel



Inox  
Stainless steel

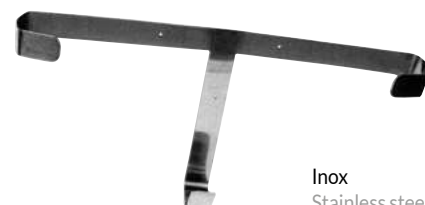

Inox  
Stainless steel

Code	DESCRIPTION
PO20102	Soporte aro salvavidas pared <i>Lifesaving wall ring holder</i>

Code	DESCRIPTION
PO20101	Soporte aro salvavidas varilla <i>Lifesaving bracket ring holder</i>

Code	DESCRIPTION
PO20100	Soporte aro salvavidas <i>Lifesaving ring holder</i>



Aluminio/inox 200 x 20 cm diámetro  
Aluminium/stainless steel 200 x 20 cm diameter

Code	DESCRIPTION
PO20300	Monitor acero inox. / aluminio <i>SS / aluminium monitor</i>



Aluminio / inox  
Aluminium stainless steel

Code	DESCRIPTION
PO20301	Monitor curvado <i>Curved monitor</i>



Code	DESCRIPTION
PO20400	Silla socorrista <i>Lifeguard chair</i>



# AUDIO AUDIO

ALTAVOZ EXTERIOR Y SUMERGIBLE  
EXTERIOR AND SUBMERSIBLE SPEAKER

## PACK AUDIO AUTÓNOMO

### SINCRO100

UD-800  
100 Wrms

### SINCRO180

UD-980  
180 Wrms

- A** **Unidad portátil megafonía**  
Módulo receptor: 2 canales UHF PLL  
Fuente musical incorporada: CD-mp3 / USB-SD  
Autonomía: de 3 a 9h  
Alimentación interna: 2 baterías 12V / 5A-h  
Alimentación externa: 100-240 VAC / 24 VDC-3A  
**2 conjuntos micrófono de diadema / emisor inalámbrico**
- B** Micrófono: Utilización de diadema - color Beige  
Módulo emisor: Fijación en cinturón
- C** **1 Altavoz subacuático AP-0130**  
Potencia: 15W  
Cobertura: Aproximadamente 50m x 10m
- D** **1 Cable de conexión altavoz subacuático**  
Longitud: 10 metros  
**1 Cable de conexión fuente música externa**  
Longitud: 1 metro  
Compatible: Reproductor mp3, iPod, móviles
- E** **Opcional: Sistema de atenuación**  
Integración de un sistema de atenuación para el audio exterior proporcionado por el equipo portátil. Por razones de seguridad eléctrica, cuando utilice el equipo en combinación con altavoces sumergibles, deberá utilizar la alimentación a batería, sin conexión a la red eléctrica.



## AUTONOMOUS AUDIO PACK

### SINCRO100

UD-800  
100 Wrms

### SINCRO180

UD-980  
180 Wrms

- A** **Portable PA system**  
Receiver module: 2 channels UHF PLL  
Built-in music source: CD-mp3 / USB-SD  
Autonomy: from 3 to 9h  
Internal power: 2 batteries 12V / 5A-h  
External power: 100-240 VAC / 24 VDC-3A
- B** **2 sets Headband microphone / wireless transmitter**  
Microphone: Use of headband - Beige color Transmitter module: Belt fixing
- C** **1 AP-0130 underwater speaker**  
Power: 15W  
Coverage: Approximately 50m x 10m
- D** **1 underwater speaker connection cable**  
Length: 10 meters  
**1 External music source connection cable**  
Length: 1 meter Compatible: MP3, iPod, mobile devices
- E** **Optional: Attenuation system**  
Integration of an attenuation system for external audio provided by the portable equipment. For reasons of electrical safety, when using the equipment in combination with submersible speakers, you must use battery power, without connection to the mains.





NDEPool



## CUBIERTAS Y ENROLLADORES POOL COVERS AND ROLLERS

# COBERTORES SOLARES DE DOBLE BURBUJAS

El cobertor solar flota sobre el agua sin amarres, se mantienen encajados en el interior de la piscina. Por su escaso peso son muy fáciles de manejar.

Un enrollador facilita su manipulación y almacenaje.

Su calidad aislante evita la pérdida de calor. Los tipos solares, además, con la acción del sol aumentan la temperatura del agua, alargando la temporada de baño en las piscinas exteriores.

Especialmente indicados para piscinas climatizadas, por su importante ahorro energético. Cumplen con las exigencias de las normativas de la RITE.

Los cobertores flotantes protegen de la caída de insectos y de la de poluciones externas.

## DOUBLE CELL SOLAR COVERS

*The cover floats on the water without moorings, it remains embedded on the interior of the pool. They are very easy to manage thanks to their light weight.*

*A roller eases their handling and storage.*

*Their insulating quality prevents the loss of heat. Moreover, the solar types increase the water temperature with the action of the sun, lengthening the bathing season in outdoor pools.*

*Especially suitable for heated pools due to their significant energy savings. All thermal covers meet the requirements of the RITE regulations.*

*The floating covers protect from falling insects and external pollutions.*

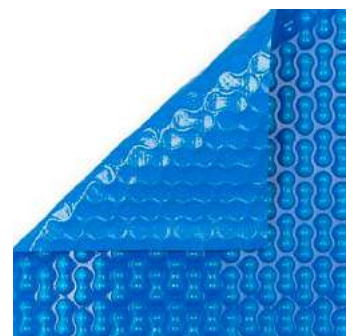

# COBERTORES POOL BLANKETS

## EICSTC | COBERTOR SOLAR TÉRMICO TRIPLE CELL

El cobertor solar térmico Triple Cell se caracteriza por proporcionar un mayor calentamiento del agua, mejor aislamiento y más durabilidad en el mantenimiento de la temperatura de la piscina. Sus particularidades se deben a su diseño de triple burbuja. Además también ofrece una mayor protección contra los rayos UV y los químicos.

El hecho de que esté fabricado con un espesor más uniforme, hace que se diferencie de la burbuja simple, donde el grosor es menos constante.

### CARACTERÍSTICAS

- Material: Lámina de polietileno, con burbujas de aire sellado de 610 micras.
- Peso: 550g/m<sup>2</sup>
- Altura burbuja: 5-6m
- Ancho: 1400mm +/- 10mm
- Espesor film tramado
- Ancho burbuja: 1300m
- Medida burbuja: 32 x 30mm

## TRIPLE CELL SOLAR COVER

*The Triple Cell Solar Pool Blanket provides better heating, better insulation and ensures the pool stays warmer for longer. This is achieved through its unique 3-way cell bubble design. It also offers more protection from chemicals and harmful UV rays.*

*The manufacturing process ensures a more uniform thickness, unlike the traditional round bubble design that has an inconsistent thickness.*

### CHARACTERISTICS

- Material: Polyethylene sheet, with a triple cell (610 micron) thickness
- Weight: 550 gr/m<sup>2</sup>
- Cell Height: 5-6 m
- Width: 1400 mm +/- 10 mm
- Thick woven film
- Cell Width: 1300 m

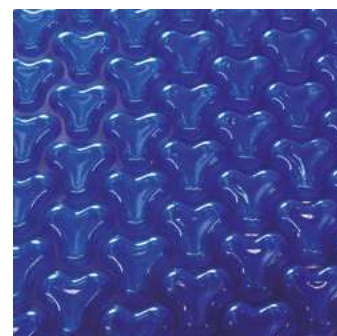

## COBERTORES POOL BLANKETS

### NDE-MOU5 | COBERTOR TÉRMICO MOUSSE ARMADA PE 5mm

El cobertor de 5 mm flota sobre el agua sin amarres, se mantienen encajados en el interior de la piscina. Por su escaso peso son muy fáciles de manejar. Un enrollador facilita su manipulación y almacenaje. Su calidad aislante evita la pérdida de calor. Los tipos solares, además, con la acción del sol aumentan la temperatura del agua, alargando la temporada de baño en las piscinas exteriores.

#### CARACTERÍSTICAS

- Espuma de polietileno reforzado por un tejido adherido y recubierto por un film de PE
- Resistencia a la tracción =200N./5cm
- Peso 470 gr/m<sup>2</sup>
- Espesor 5mm
- Temperaturas extremas -20° y +38°

### THERMICAL REINFORCED COVER MOUSSE 5mm

*The 5mm cover floats on the water without moorings, it remains embedded on the interior of the pool. They are very easy to manage thanks to their light weight. A roller eases their handling and storage. Their insulating quality prevents the loss of heat. Moreover, the solar types increase the water temperature with the action of the sun, lengthening the bathing season in outdoor pools. The Mousse floating cover is highly suitable for indoor or outdoor heated pools. A roller eases its handling.*

#### CHARACTERISTICS

- Polyethylene foam reinforced by an adhered fabric and covered in a film of PE
- Resistance to traction =200N./5 cm
- Weight 470 g/m<sup>2</sup>
- Thickness 5mm



## COBERTORES POOL BLANKETS

### NDE-MOU8 | COBERTOR TÉRMICO MOUSSE SUPERFLEX PE 8mm

El cobertor superflex flota sobre el agua sin amarres, se mantienen encajados en el interior de la piscina. Por su escaso peso son muy fáciles de manejar. Un enrollador facilita su manipulación y almacenaje. Su calidad aislante evita la pérdida de calor. Los tipos solares, además, con la acción del sol aumentan la temperatura del agua, alargando la temporada de baño en las piscinas exteriores.

#### CARACTERÍSTICAS

- Espuma de polietileno reforzado por un tejido adherido de poliéster y recubierto por un film de PE
- Resistencia a la tracción =200N./5cm
- Peso 900 gr/m<sup>2</sup>
- Espesor 8mm
- Temperaturas extremas -20° y +40°

### THERMICAL SUPERFLEX COVER MOUSSE 8mm

*The superflex cover floats on the water without moorings, it remains embedded on the interior of the pool. They are very easy to manage thanks to their light weight. A roller eases their handling and storage. Their insulating quality prevents the loss of heat. Moreover, the solar types increase the water temperature with the action of the sun, lengthening the bathing season in outdoor pools.*

#### CHARACTERISTICS

- Polyethylene foam reinforced by an adhered polyester fabric and covered in a film of PE
- Resistance to traction =200N./5 cm
- Weight 900 g/m<sup>2</sup>
- Thickness 8mm
- Extreme temperatures -20° and +40°

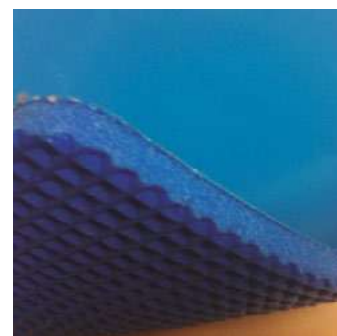

## COBERTOR ENROLLABLES NDE-ZIP SLIDING SAFETY COVER

La cubierta Poolzip es nuestra propuesta más avanzada para clientes exigentes. Diseñada con precisión para mantener la membrana tensada y sellada, cuenta con un motor que facilita su despliegue y recogida. La membrana microperforada con tecnología de pretensado protege contra daños potenciales como la contaminación y los rayos UV. A diferencia de otros cobertores, se mantiene separado del nivel del agua, creando una cámara de aire aislante que conserva el calor para un baño más comfortable.

*The Poolzip cover is our most advanced offering for discerning customers. Precisely engineered to keep the membrane taut and sealed, it features a motor that makes it easy to deploy and retract. The micro-perforated membrane with pre-tensioning technology protects against potential damage such as pollution and UV rays. Unlike other covers, it remains separated from the water level, creating an insulating air chamber that retains heat for a more comfortable swim.*



## COBERTOR ENROLLABLES NDE-ORE SLIDING SAFETY COVER

El Cobertor Oré destaca como una solución cómoda y segura para salvaguardar su piscina. Gracias a su motor puede enrollar y desenrollar automáticamente mediante un práctico mando a distancia. Además, el cierre seguro y firme reduce el riesgo de caídas accidentales.

Su membrana elaborada con PVC, garantiza una durabilidad excepcional, ofreciendo una protección efectiva y prolongada para su piscina.

*The Oré cover stands out as a comfortable and safe solution to safeguard your pool. Thanks to its motor, it can be rolled up and unrolled automatically using a practical remote control. In addition, the secure and firm closure reduces the risk of accidental falls.*

*Its membrane made of PVC guarantees exceptional durability, offering effective and long-lasting protection for your pool.*





# ENROLLADORES ROLLERS

EIENROL



Además del material del cobertor térmico para piscinas, ofrecemos varias opciones y tipos de enrolladores:

- Enrolladores con instalación fija
- Enrolladores con instalación móvil
- Enrolladores de instalación elevada
- Enrolladores de instalación sumergida

Todas de manipulación manual de fácil maniobra o motorizada, con estructura de aluminio lacado y cilindro anonizado.

*In addition to the thermal cover material for swimming pools, we offer several options and types of rollers:*

- *Rollers with fixed installation*
- *Rollers with mobile installation*
- *Rollers with elevated installation*
- *Rollers with submerged installation*

*All manual with easy maneuver or motorised, with lacquered aluminum structure and anonised cylinder.*



**CUBIERTAS AUTOMÁTICAS**  
AUTOMATIC COVERS

# CUBIERTAS AUTOMÁTICAS

## AUTOMATIC COVERS

- Lamas de perfil extrusionado de PVC o policarbonato.
- Alta resistencia.
- Conforme con normativa NPF-308 de seguridad.
- Perfiles de cámaras huecas, 3 cámaras herméticas, y conexión con doble gancho, sellados por los extremos, que aseguran su flotabilidad.
- Abertura especial en la parte inferior que permite evacuar con agua los desechos. Esto previene tanto las acumulaciones de residuos como el desarrollo de algas en la parte inferior de la unión del gancho.
- Cuenta con un orificio extra para limpiar la lama a presión.
- Medidas: 72 x 17 mm.
- Peso: PVC 4,3 Kg/m<sup>2</sup> / PC 3,6 Kg/m<sup>2</sup>.
- Capacidad de flotación: 82,4 N/m<sup>2</sup>.
- Tapones: Impermeabilización y fijación mediante cámara de silicona de 15mm.
- Producción: Plástico PVC modificado extrusionado o coextrusionado con UV Plus de alta calidad.

- *Extruded PVC or polycarbonate profile slats.*
- *High resistance.*
- *Compliant with safety standard NPF-308.*
- *Profiles of hollow chambers, 3 hermetic chambers, and connection with double hook, sealed by the ends, which ensure its buoyancy.*
- *Special opening in the lower part that allows waste to be evacuated with water. This prevents both waste accumulations and the development of algae in the lower part of the hook connection.*
- *Extra hole to clean the pressure blade.*
- *Measurements: 72 x 17 mm.*
- *Weight: PVC 4.3 Kg / m<sup>2</sup> / PC 3.6 Kg / m<sup>2</sup>.*
- *Floating capacity: 82.4 N / m<sup>2</sup>.*
- *Plugs: Waterproofing and fixing by means of a 15mm silicone camera.*
- *Production: Modified PVC plastic extruded or coextruded with UV Plus of high quality.*

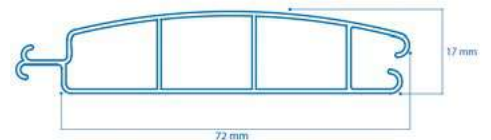
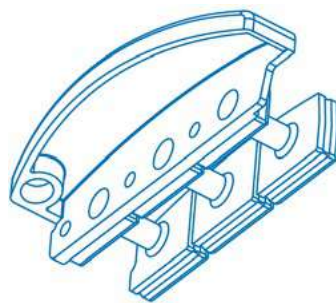

### COLORES COLOURS

#### PVC



White

Grey

Beige

Blue

#### Policarbonate



Blue  
Transparent

Blue  
Solar

Transparent  
solar

Transparent

# CUBIERTAS AUTOMÁTICAS

## AUTOMATIC COVERS

### NDE-E

#### Cubiertas automáticas fijas

En un lateral de piscina, con pies de aluminio lacado, pletinas de fijación de acero inoxidable regulables que garantizan una fácil colocación sobre suelos desnivelados, consiguiendo una perfecta verticalidad.

#### OPCIONES

##### MODELO MOTORIZADO

Cubiertas automáticas con motor tubular de 24v. con reguladores de final de recorrido. Accionados por un conmutador a llave de tres posiciones. Incluye el transformador. Posibilidad de captador solar o de mando a distancia.

##### MODELO MANUAL

Accionamiento manual por manivela conectada a una máquina desmultiplicadora, que facilita la operación. Medidas máximas de la cubierta 20 m<sup>2</sup>.

#### Fixed automatic covers

On one side of the pool, with lacquered aluminum feet, adjustable stainless steel heating plates that guarantee an easy installation on uneven floors, achieving a perfect verticality.

#### OPTIONS

##### MOTORIZED MODEL

Automatic covers with tubular motor of 24v. with end of travel regulators. Powered by a three-position key switch. Includes the transformer. Possibility of solar collector or remote control.

##### MANUAL MODEL

Manual operation by crank connected to a demultiplier machine, which facilitates the operation. Maximum dimensions of the cover 20 m<sup>2</sup>.



**Consultar Opcionales:** Kit electrólisis salina, kit cintas o ganchos de seguridad, mando a distancia.

**Ask for accessories:** Electrolysis kit, safety traps Kit, remote control.

# CUBIERTAS AUTOMÁTICAS

## AUTOMATIC COVERS

### NDE-EL

#### Cubiertas automáticas fijas de diseño

Cubierta fija de elegante diseño para los más exigentes. Con tornillería a suelo oculta. Fabricados completamente en aluminio lacada antracita, incorpora luces led RGB y mando multicanal.

#### OPCIONES

#### MODELO MOTORIZADO

Cubiertas automáticas con motor tubular de 24v. con reguladores de final de recorrido. Accionados por un conmutador a llave de tres posiciones. Incluye el transformador. Posibilidad de captador solar o de mando a distancia.

#### MODELO MANUAL

Accionamiento manual por manivela conectada a una máquina desmultiplicadora, que facilita la operación. Medidas máximas de la cubierta 20 m<sup>2</sup>.

#### Well designed fixed automatic covers

Fixed cover with elegant design for the most demanding. With hidden floor screws. Made entirely of anthracite lacquered aluminum, it incorporates RGB LED lights and multi-channel control.

#### OPTIONS

#### MOTORIZED MODEL

Automatic covers with tubular motor of 24v. with end of travel regulators. Powered by a three-position key switch. Includes the transformer. Possibility of solar collector or remote control.

#### MANUAL MODEL

Manual operation by crank connected to a demultiplier machine, which facilitates the operation. Maximum dimensions of the cover 20 m<sup>2</sup>.



**Consultar Opcionales:** Kit electrólisis salina, kit cintas o ganchos de seguridad, mando a distancia.

**Ask for accessories:** Electrolysis kit, safety traps Kit, remote control.

# CUBIERTAS AUTOMÁTICAS

## AUTOMATIC COVERS

### NDE-A

#### Enrolladores móviles sobre guías.

Muy ligero y fácil. Sin desvíos ni correcciones. Una sola persona desplaza el enrollador por su sistema de rodamientos y guías de acero inoxidable, desde su emplazamiento hasta el borde de la piscina.

#### CARACTERÍSTICAS

- Bastidor de aluminio lacado, tornillería y accesorios de acero inoxidable.
- Motor tubular de 24 v. con reguladores de final de recorrido.
- Fácilmente ocultable en cualquier habitáculo o en cofres modelo Box.
- Conmutador a llave de tres posiciones y con opción de mando a distancia.
- Guías de 3 metros.

#### Mobile rollers on guides.

Very light and easy. No detours or corrections. A single person displaces the roller by its system of stainless steel bearings and guides, from its location to the edge of the pool.

#### CHARACTERISTICS

- Lacquered aluminum frame, screws and stainless steel accessories.
- Tubular motor of 24 v. with end of journey regulators.
- Easily hidden in any cabin or in chest model Box.
- Three-position key switch with remote control option.
- 3 meter guides.



**Consultar Opcionales:** Kit electrólisis salina, kit cintas o ganchos de seguridad, mando a distancia.

**Ask for accessories:** Electrolysis kit, safety traps Kit, remote control.

# CUBIERTAS AUTOMÁTICAS

## AUTOMATIC COVERS

### NDE-B

#### Cubiertas en cofres.

Cubiertas automáticas con un estético habitáculo de ocultación y protección.

#### CARACTERÍSTICAS

- Bastidor de aluminio lacado con frontales de malla de Poliéster, para airear el compartimiento interior.
- Fácil acceso al interior por frontales practicables para una limpieza periódica sencilla y a chorro de manguera.
- Bastidor con pletinas de fijación al suelo de acero inoxidable regulables, que garantizan una perfecta y sencilla posición de apoyo.
- Motores tubulares de 24 v. con reguladores de paro en final de recorrido.
- Conmutador a llave de tres posiciones y en opción de mando a distancia.
- Gran resistencia, aguanta hasta 200 kg de peso.

#### MEDIDAS

- 650 x 600 mm - hasta 10 metros lineales.
- 750 x 720 mm - hasta 15 metros lineales.

*Retractable covers in chests.*

*Automatic covers with an aesthetic hiding and protection compartment.*

#### CHARACTERISTICS

- *Lacquered aluminum frame with polyester mesh front, to aerate the interior compartment.*
- *Easy access to the interior by open fronts for a simple periodic cleaning and hose jet.*
- *Frame with adjustable stainless steel floor plates, which guarantee a perfect and simple support position.*
- *Tubular motors of 24 v. with stop controllers at the end of the journey.*
- *Key switch with three positions and remote control option.*
- *Great resistance, holds up to 200 kg of weight.*

#### MEASUREMENTS

- *650 x 600 mm - up to 10 linear meters.*
- *750 x 720 mm - up to 15 linear meters.*



**Consultar Opcionales:** Kit electrólisis salina, kit cintas o ganchos de seguridad, mando a distancia.

**Ask for accessories:** Electrolysis kit, safety traps Kit, remote control.

# CUBIERTAS AUTOMÁTICAS

## AUTOMATIC COVERS

### NDE-L

#### Cubiertas con enrolladores sumergidos.

Cuando no están en servicio las cubiertas desaparecen en el agua. El enrollador motorizado con tubo y accesorios de acero inoxidable, recoge la cubierta en el fondo de la piscina. Nada se ve exteriormente y el entorno de la piscina queda limpio y totalmente diáfano.

#### CARACTERÍSTICAS

- Motores de 24 v. con paros automáticos, al final del recorrido.
- Conmutador a llave de tres posiciones con opción de mando a distancia.
- Con opción de tarima en la cabeza de la piscina, cubriendo el espacio en que se halla sumergido el enrollador. La tarima se coloca sobre vigas de soporte y quedan totalmente ocultas. El espacio de tarima es totalmente transitable y utilizable. Es posible combinar más de un enrollador para conseguir cubriciones en piscinas irregulares.
- A través de un sencillo mecanismo de guía, estas cubiertas funcionan perfectamente sobre piscinas desbordantes.
- Incluye kit electrólisis salina.

*Covers with submerged rollers.*

*When they are not in service the covers disappear in the water. The motorized roller with stainless steel tube and accessories picks up the cover at the bottom of the pool. Nothing is seen outside and the surroundings of the pool are clean and totally transparent.*

#### CHARACTERISTICS

- 24 V motors with automatic stops, at the end of the journey.
- Three-position key switch with remote control option.
- With option of platform in the head of the pool, covering the space in which the froller is submerged. The platform is placed on support beams and they are completely hidden. The platform space is fully walkable and usable. It is possible to combine more than one roller to cover irregular pools.
- Through a simple guide mechanism, these covers work perfectly on overflow pools.
- Includes electrolysis kit.



**Consultar Opcionales:** Kit desbordamiento, kit cintas o ganchos de seguridad, tapa madera tecnológica, vigas, pared separación, mando a distancia.

**Ask for accessories:** infinity pool kit, safety traps kit, synthetic platform, beams, wall separation, remote control.





CUBIERTAS MODULARES  
ENCLOSURES



# CUBIERTAS MODULARES Plana

## ENCLOSURES Flat

### NDE-PL-AM

De discreta y elegante apariencia, esta estructura está compuesta por diversos módulos de policarbonato celular.

Se complementa con una sólida estructura de aluminio de primera fundición, ofreciendo incluso la opción de un sistema de brazos hidráulicos. Este innovador sistema posibilita la apertura y cierre de los distintos módulos con la misma facilidad con la que abre el maletero de su coche, proporcionando una experiencia de uso cómodo y eficiente.

*Discreet and elegant in appearance, this structure is made up of various cellular polycarbonate modules.*

*It is complemented by a solid cast aluminium structure, even offering the option of a hydraulic arm system. This innovative system makes it possible to open and close the various modules with the same ease with which you open the boot of your car, providing a comfortable and efficient user experience.*



# CUBIERTAS MODULARES Plana ENCLOSURES Flat

NDE-SM-FL

Con el objetivo de proporcionar un soporte robusto que pueda resistir hasta 150 kg/m<sup>2</sup>, esta tarima móvil asegura una total seguridad al caminar sobre ella. Su ingenioso sistema se adapta con facilidad a cualquier piscina, convirtiéndola en un versátil espacio multiusos que amplía significativamente su área de disfrute.

*With the aim of providing a robust support that can withstand up to 150 kg/m<sup>2</sup>, this mobile platform ensures total safety when walking on it. Its ingenious system adapts easily to any pool, making it a versatile multi-purpose space that significantly expands your enjoyment area.*



# CUBIERTAS MODULARES Baja ENCLOSURES Low

## NDE-SM-XS

Cubierta telescópica de perfil ultra bajo, equipada con un sistema modular deslizante que posibilita la apertura rápida de la piscina, ya sea de manera manual o motorizada, en cuestión de segundos. Su altura en la parte más elevada es de 30 cm en el módulo más bajo, incrementándose en solo 7cm por cada módulo adicional. Este diseño consta de módulos independientes con movilidad sobre ruedas, permitiendo su desplazamiento tanto con raíles como sin ellos.

*Ultra-low profile telescopic cover, equipped with a modular sliding system that allows the pool to be opened quickly, either manually or motorized, in a matter of seconds. Its height at the highest point is 30 cm in the lowest module, increasing by only 7 cm for each additional module. This design consists of independent modules with mobility on wheels, allowing it to be moved both with and without rails.*



# CUBIERTAS MODULARES Medio

## ENCLOSURES Medium

NDE-SM-ME

Este modelo de cubierta destaca por su comodidad y altura, perfecta para disfrutar de un baño en su interior. Con aproximadamente 80 cm de altura en su módulo más pequeño, incrementándose en solo 7 cm por módulo, esta versión ofrece versatilidad. Puede disfrutar de su funcionamiento tanto de forma manual como motorizada, con la opción de utilizar railes en el suelo o prescindir de ellos.

*This model of cover stands out for its comfort and height, perfect for enjoying a bath inside. With approximately 80 cm of height in its smallest module, increasing by only 7 cm per module, this version offers versatility. You can enjoy its operation both manually and motorized, with the option of using rails on the floor or not at all.*



# CUBIERTAS MODULARES Curva

## ENCLOSURES Curve

### NDE-TEL-AM

Nuestro modelo estrella en ventas es una cubierta totalmente corredera y sin rieles en el suelo. Sus módulos telescópicos se deslizan perfectamente debajo del siguiente, liberando completamente su piscina. Los perfiles de la cubierta presentan una curvatura uniforme y suave, con un sistema de doble guiado interior que facilita su apertura y cierre. Además, ofrecemos opciones de personalización como la cubierta híbrida o el efecto cristal para que pueda adaptarla según sus preferencias.

*Our top-selling model is a fully sliding cover with no floor rails. Its telescopic modules slide perfectly under the next one, completely freeing up your pool. The cover profiles have a uniform and smooth curvature, with a double internal guide system that makes it easy to open and close. In addition, we offer customization options such as the hybrid cover or the glass effect so that you can adapt it to your preferences.*



# CUBIERTAS MODULARES Alta ENCLOSURES High

NDE-SM-H

Cubierta 100% telescópica sin rieles en el suelo. Las puertas de acceso pueden ser frontales o laterales manteniendo así el confort de su terraza. Los frontales pueden ser basculantes, lo cual permite abrir la cubierta en verano sin tener que desmontar escaleras o trampillas. adicionalmente, los módulos y las puertas correderas llevan cerradura para su máxima tranquilidad..

*100% telescopic cover without rails on the floor. The access doors can be front or side, thus maintaining the comfort of your terrace. The front doors can be tilted, which allows the cover to be opened in summer without having to remove stairs or trapdoors. In addition, the modules and sliding doors have a lock for your maximum peace of mind.*



# CUBIERTAS MODULARES Personalizadas

## ENCLOSURES Customized

### NDE-MIX

Nos adaptamos a sus necesidades diseñando y fabricando el proyecto que desee a su medida. Una combinación de módulos altos con módulos bajos, manuales o motorizados podrán ser parte de su nuevo proyecto.

*We adapt to your needs by designing and manufacturing the project you want to suit your needs. A combination of high modules with low modules, manual or motorized, can be part of your new project.*





# CUBIERTAS MODULARES Pérgolas bioclimáticas

## ENCLOSURES Bioclimatic pergola

### NDE-PER

Formadas por lamas de aluminio que son orientables de manera automática a través de tu móvil. Según quieras más o menos luz puedes modificar el ángulo de sus lamas y conseguir que el aire circule, que entre más el sol o crear la sombra que necesites para leer, comer o disfrutar entre amigos de tu terraza.

Además mediante la selección de materiales puedes adaptarla perfectamente al estilo arquitectónico de tu vivienda.

*They are made up of aluminium slats that can be automatically adjusted using your mobile phone. Depending on whether you want more or less light, you can modify the angle of the slats and allow air to circulate, let in more sunlight or create the shade you need to read, eat or enjoy your terrace with friends. In addition, by selecting the materials you can perfectly adapt it to the architectural style of your home.*



REVESTIMIENTOS POOL FINISHES

## MOSAICO VÍTREO GLASS MOSAIC TILES

Arte, calidad, tradición, diseños de vanguardia e innovación son palabras que describen la calidad de nuestros productos de revestimiento vítreo para baños, piscinas y spas.

La paleta de colores y multiformatos es infinita. Colecciones que permiten colocar el producto y decorar los espacios con más personalidad.

Disponemos de una gran variedad de mosaicos como cenefas, diseños de fondo, multigradados, luminescentes y antideslizantes.

Disponemos de distintos colores formatos. Solicitar catálogo.

*Art, quality, tradition, avant-garde designs and innovation are words that describe the quality of our glass mosaic tile finishing products for baths, pools and spas.*

*The colour palette and multiformats is infinite. Collections that allow you to place the product and decorate the spaces with more personality.*

*We manufacture all kinds of tiles such as borders, bottom floor designs, multigraded designs, luminescent and anti-slip tiles.*

*Please ask us for different colours and sizes.*

## LISOS SOLID

Consultar para las referencias disponibles en acabado antideslizante.

*Please ask for anti-slip tile codes.*

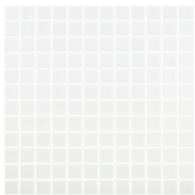

EV100

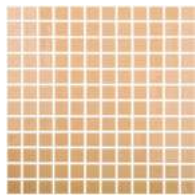

EV101

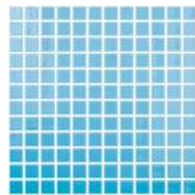

EV102

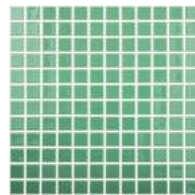

EV600

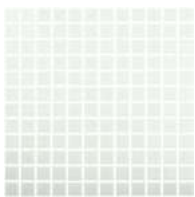

EV103

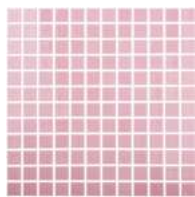

EV105

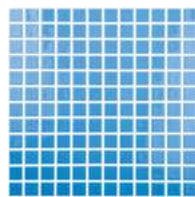

EV106

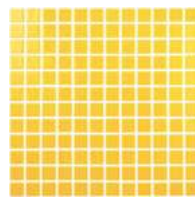

EV800

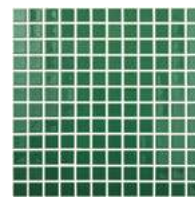

EV602

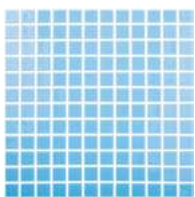

EV107

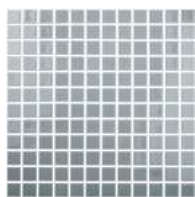

EV108

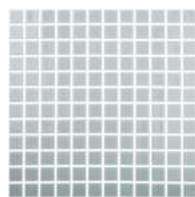

EV109

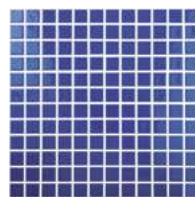

EV803

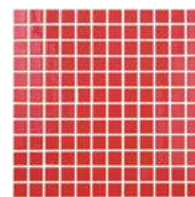

EV808



EV900

# NIEBLA FOG

Consultar para las referencias disponibles en acabado antideslizante.

*Please ask for anti-slip tile codes.*

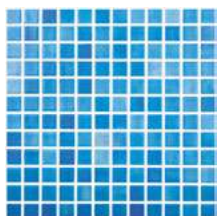

EV110

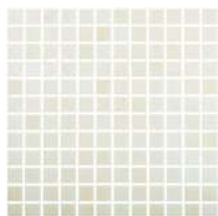

EV500

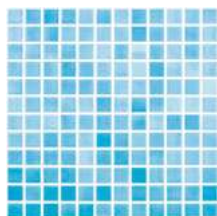

EV501

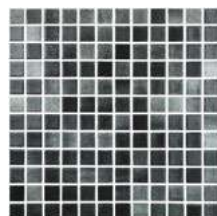

EV509

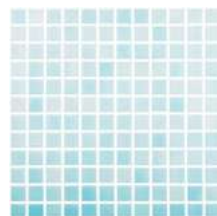

EV510

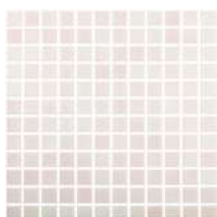

EV502

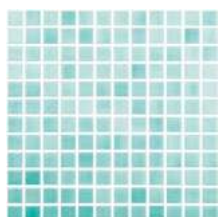

EV503

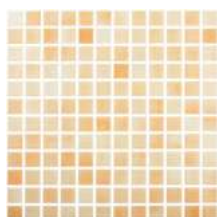

EV504

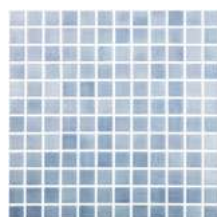

EV512

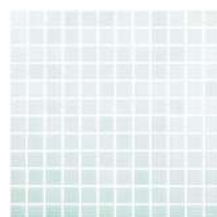

EV511

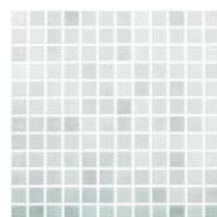

EV514



EV506



EV507

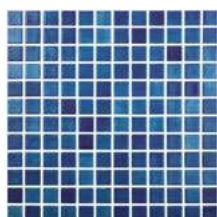

EV508

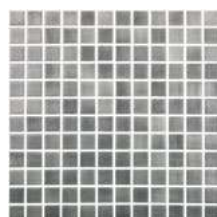

EV515

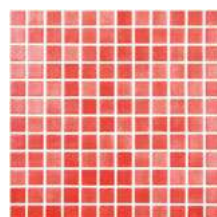

EV805

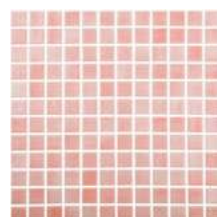

EV06



# LUMINISCENTE LUMINISCENT

Se trata de un tipo de mosaico que posee la propiedad de emitir luz después de haber cesado la exposición a la fuente luminosa. Brilla en la oscuridad creando efectos artísticos y visuales únicos. Bajo iluminación común, este mosaico presenta un aspecto totalmente normal.

*It is a mosaic that has the capacity to project light after the exposure of a light source. It glows in the dark creating unique visual and artistic effects. Under common light, this mosaic shows a completely standard look.*

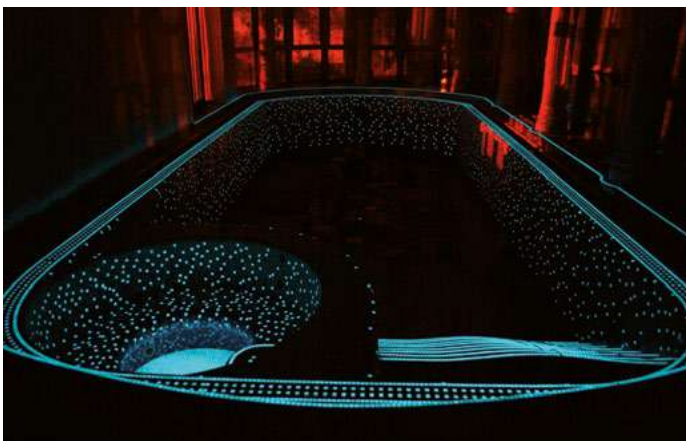
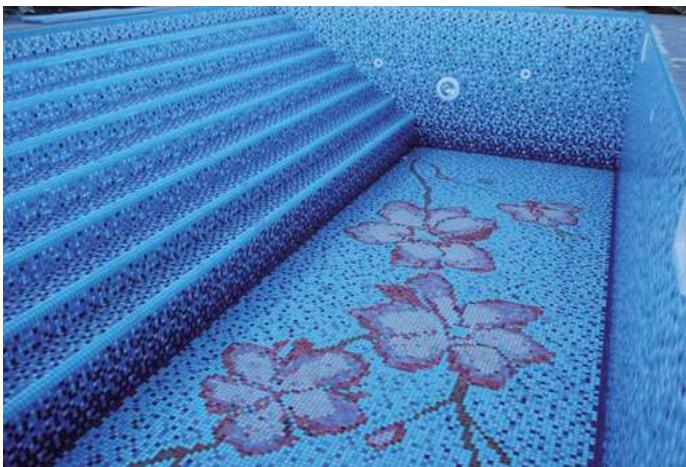
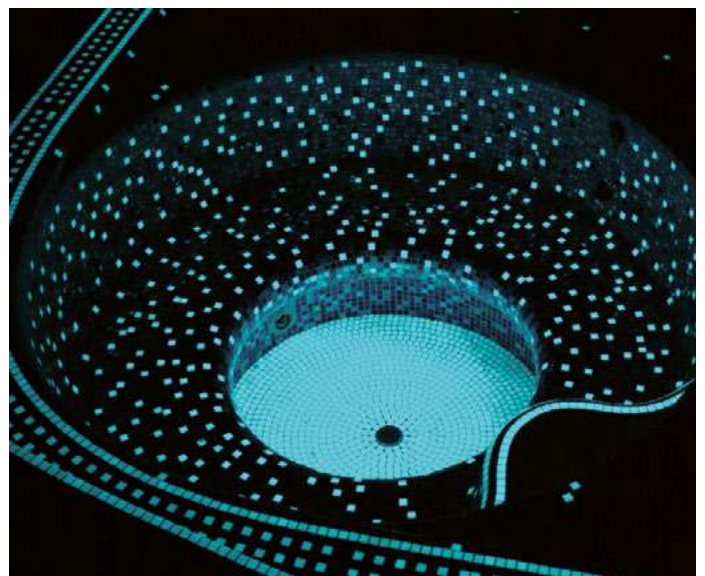
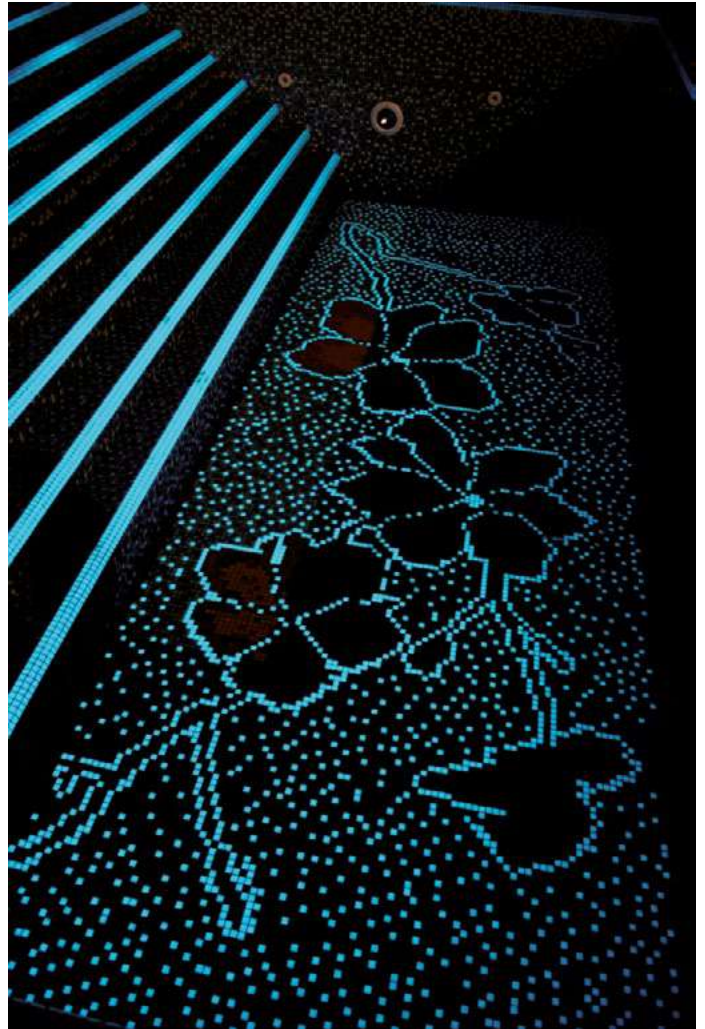

# CENEFAS BORDERS



Code: EVCENEFA1  
Height in pieces: 5  
Measurement/unit: 31,7 x 13,2 cm  
Colours: EV100/EV805/EV808/EV900



Code: EVCENEFA2  
Height in pieces: 5  
Measurement/unit: 31,7 x 13,2 cm  
Colours: EV100/EV507/EV600/EV900



Code: EVCENEFA7  
Height in pieces: 5  
Measurement/unit: 26,42 x 13,2 cm  
Colours: EVF100/EVD803/EV106



Code: EVCENEFA3  
Height in pieces: 6  
Measurement/unit: 21,13 x 15,84 cm  
Colours: EVF100/EVD106/EV801/EV803

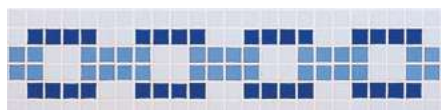

Code: EVCENEFA4  
Height in pieces: 6  
Measurement/unit: 31,7 x 15,84 cm  
Colours: EVF100/EVD106/EV803



Code: EVCENEFA8  
Height in pieces: 6  
Measurement/unit: 31,7 x 18,49 cm  
Colours: EVF100/EVD803

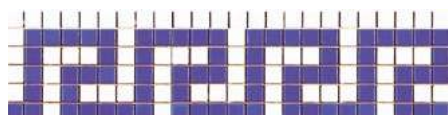

Code: EVCENEFA9  
Height in pieces: 6  
Measurement/unit: 31,7 x 15,84 cm  
Colours: EVF100/EVD803



Code: EVCENEFA10  
Height in pieces: 7  
Measurement/unit: 31,7 x 18,49 cm  
Colours: EVF100/EVD507/EV602/EV900



Code: EVCENEFA11  
Height in pieces: 7  
Measurement/unit: 18,49 x 18,49 cm  
Colours: EVF100/EVD106/EV801/EV803



Code: EVCENEFA5  
Height in pieces: 7  
Measurement/unit: 31,7 x 18,49 cm  
Colours: EVF100/EVD803



Code: EVCENEFA6  
Height in pieces: 7  
Measurement/unit: 31,7 x 15,84 cm  
Colours: EVF100/EVD509/EV805



Code: EVCENEFA12  
Height in pieces: 7  
Measurement/unit: 31,7 x 18,49 cm  
Colours: EVF100/EVD803/EV106



Code: EVCENEFA3II  
Height in pieces: 8  
Measurement/unit: 31,7 x 21,13 cm  
Colours: EVF100/EVD803



Code: EVCENEFA4II  
Height in pieces: 8  
Measurement/unit: 24,62 x 21,13 cm  
Colours: EV100/EV106/EV803



Code: EVCENEFAOLAS  
Height in pieces: 10  
Measurement/unit: 31,7 x 26,41 cm  
Colours: EVF100/EVD803

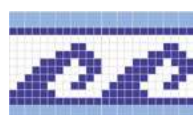

Code: EVCENEFAOLASII  
Height in pieces: 10  
Measurement/unit: 12 x 12 cm  
Colours: EVF100/EVD803

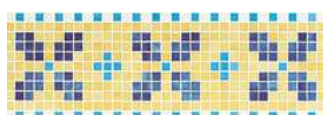

Code: EVCENEFA10II  
Height in pieces: 11  
Measurement/unit: 31,7 x 29,05 cm  
Colours: EVF504/EVD100/EV106/EV508

# DISEÑO PERSONALIZADO CUSTOMISED DESIGN

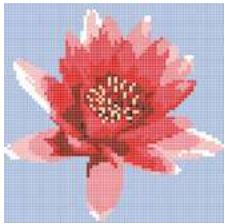

Code: EVFLOREDELOTO



Code: EVFLOREDELOTO2

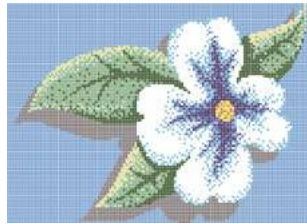

Code: EVFLORLILA

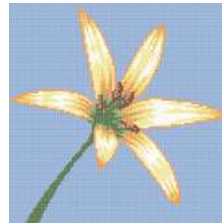

Code: EVFLOR



Code: EVMARGARITA



Code: EVMARYLIN1



Code: EVMARYLIN2



Code: EVLEOPARDO



Code: EVROSA

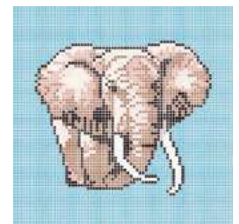

Code: EVELEFANTE



Code: EVDELFINGRANDE

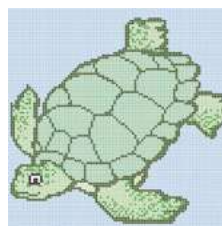

Code: EVTORTUGAMARINA



Code: EVLAGARTO



Code: EVDELFINLINEA

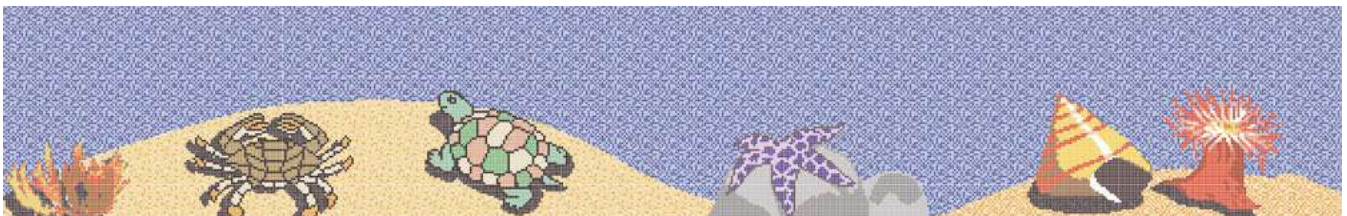

Code: EVFONDOMAR



Code: EVCACTUS



Code: EVRETRATO



Code: EVCONCHAS

Consultar sobre diseños personalizados, dimensiones y colores.  
Please ask about customised designs dimensions and colours.

# FONDOS ESTÁNDAR

## STANDARD BOTTOM DESIGNS

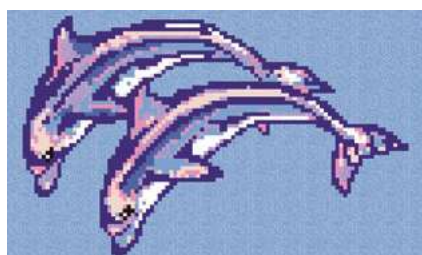

Code: EVPAREJADEDELFINES



Code: EVESTRELLA

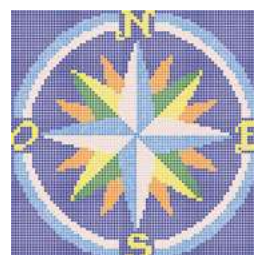

Code: EVC-10



Code: EVANCLA

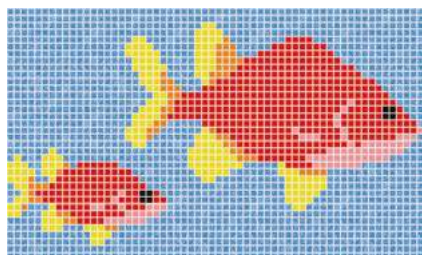

Code: EVPECESROJOS

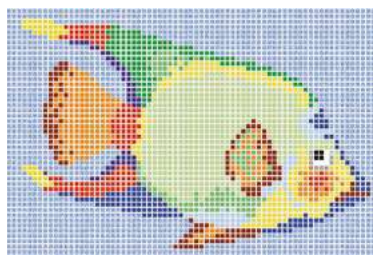

Code: EVPEZFRESH

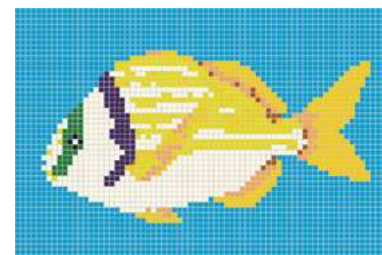

Code: EVPEZHAPPY

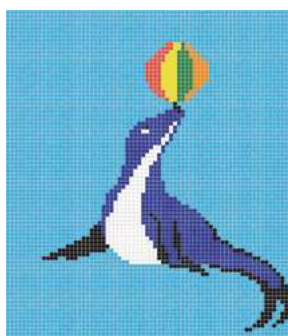

Code: EVFOCA

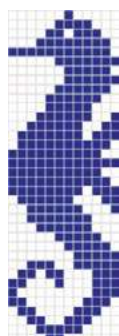

Code: EVCABALLITODEMAR

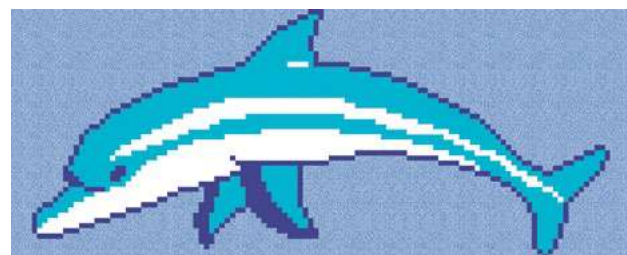

Code: EVDELFINMARINO



Code: EVSOL

Consultar sobre diseños personalizados, dimensiones y colores.  
Please ask about customised designs dimensions and colours.



NDEPool

TARIMAS DECK

## TARIMAS DECKS

**NDE201** es uno de nuestros modelos más comercializados, por su diseño adaptable a todo tipo de ambientes y por su relación calidad/precio.

Ofrece en una sola pieza la superficie Lisa o Relieve, para escoger o combinar, y se puede instalar con sistema de clip oculto (con junta de 2mm) o a la vista (junta de 5-7mm). Es un producto de bajo mantenimiento y alta durabilidad, resistente al clima y respetuoso con el medio ambiente, (hecho a base de fibras de madera reciclada y de polietileno/polipropileno, también reciclado).

Cumple con las normativas actuales y dispone de CE y test report para el mercado europeo.

**NDE401** está especialmente diseñada para cualquier zona de tránsito intenso, residencial o comercial. Tiene un revestimiento exterior en toda su superficie, que le proporciona un 100% de protección ante las manchas más comunes en espacios como centros comerciales, piscinas o restaurantes.

**NDE401** Madera-Relieve, es la tarima con menores necesidades de mantenimiento del mercado. Y gracias a nuestro acabado relieve ofrece mayor sujeción al deslizamiento en zonas húmedas como baños o piscinas.

Respetuosa con el medio ambiente, cumple con la normativa actual y cuenta con CE y test report.

*NDE 201 is one of our most commercialised models, due to its design adaptable to all types of environments and for its quality/ price ratio.*

*It is offered in one piece plain or striped surface, to choose or combine, and can be installed with hidden clip system (with 2mm joint) or in sight (5-7mm joint). It is a product of low maintenance and high durability, weather resistant and respectful with the environment, (made based on recycled wood fibers and polyethylene/polypropylene, also recycled).*

*It complies with the current regulations and has CE and test report for the European market.*

*NDE 401 is specially designed for any area residential or commercial. It has an outer coating on its entire surface, which provides 100% protection against the most common stains in spaces such as shopping centers, pools or restaurants.*

*NDE 401 is the deck with the lowest maintenance needs in the market. And thanks to our embossed finish offers greater support to sliding in wet creas such as bathrooms or pools.*

*Respectful with the environment, complies with current regulations and has CE and test report.*

# TARIMAS NDE 201

## DECKS NDE 201

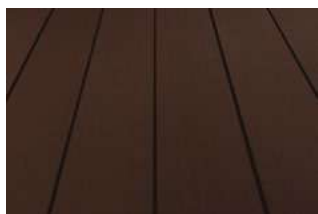
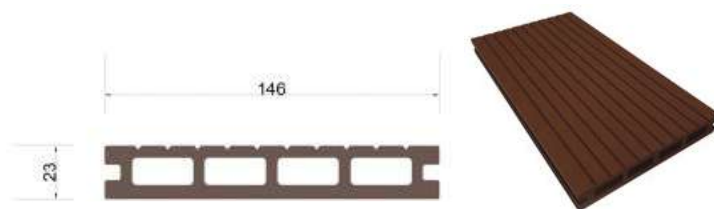

Roble Liso

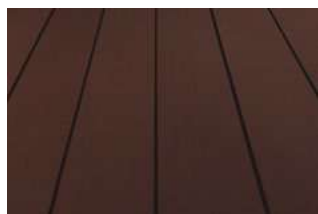

Ipé Liso

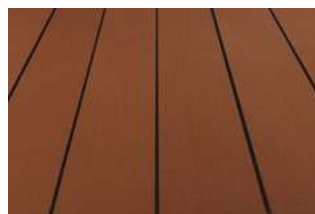

Teka Liso

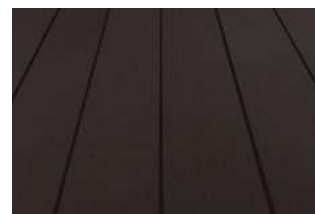

Ceniza Liso

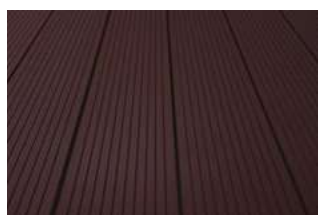

Roble Rayado



Ipé Rayado



Teka Rayado

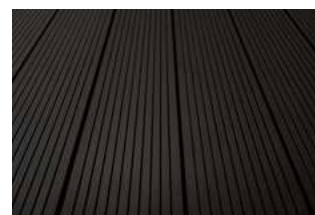

Ceniza Rayado



Ángulo



Zócalo



Rastrel de Pino R4



Rastrel WPC



Tornillo y Taco



Clip inox con tornillo  
fijación oculta



Clip inicio inox con tornillo  
fijación vista



Clip plástico con tornillo

Code	Reference	Measurements (mm) / sets / units
Roble Liso EP201RL	Oak Plain	146 x 23 x 2200
Roble Rayado EP201RR	Oak Striped	146 x 23 x 2200
Ipé Liso EP2011L	Ipe Plain	146 x 23 x 2200
Ipé Rayado EP201IR	Ipe Striped	146 x 23 x 2200
Teka Liso EP201TL	Teak Plain	146 x 23 x 2200
Teka Rayado EP201TR	Teak Striped	146 x 23 x 2200
Ceniza Liso EP201CL	Ash Plain	146 x 23 x 2200
Ceniza Rayado EP201CR	Ash Striped	146 x 23 x 2200
Anclaje EPA45	Angle	45 x 45 x 2200
Zócalo EPZC70	Skirting board	71 x 11 x 2200
Rastrel de Pino EPRPI	Pine joist R4	40 x 30 x 220 for every 3 lm
Rastrel WPC EPRWP	WPC joist	40 x 25 x 2200 for every 3 lm
Tornillo y Taco EPTT880	Screw & anchor	8 x 80 / 9 units
Clip Inox EPCLIP	SS clip hidden system	24 sets
Clip PVC Vista EPPVC	PVC clip at sight system	24 sets
Clip Inox Inicio EPCLI	SS start clip with screw	3 units

En cada palet: 98,94 m<sup>2</sup> / 308 piezas. Por m<sup>2</sup>: 3,12 piezas de 2,2 ml

# TARIMAS NDE 401

## DECKS NDE 401

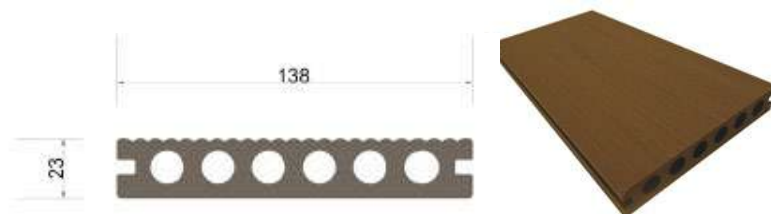

Nogal Madera



Ipé Madera



Teka Madera



Gris Madera



Nogal Relieve

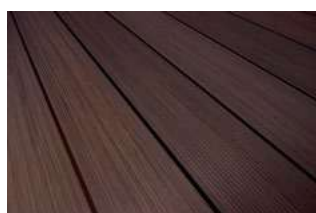

Ipé Relieve

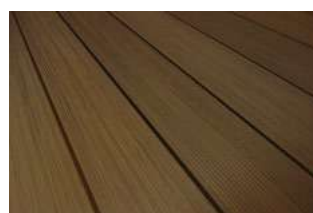

Teka Relieve



Gris Relieve



Ángulo



Rastrel de Pino R4



Rastrel WPC



Tornillo y Taco



Clip inox con tornillo fijación oculta

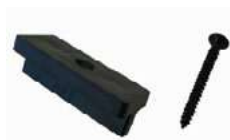

Clip inicio inox con tornillo fijación vista



Clip plástico con tornillo

Code	Reference	Measurements (mm) / sets / units
Nogal Madera EP401NM	Walnut Wood	138 x 23 x 2200
Nogal Relieve EP401NR	Walnut Raised	138 x 23 x 2200
Ipé Madera EP401IM	Ipe Wood	138 x 23 x 2200
Ipé Relieve EP401IR	Ipe Raised	138 x 23 x 2200
Teka Madera EP401TM	TeakWood	138 x 23 x 2200
Teka Relieve EP401TR	Teak Raised	138 x 23 x 2200
Gris Madera EP401GM	Grey Wood	138 x 23 x 2200
Gris Relieve EP401GR	Grey Raised	138 x 23 x 2200
Ángulo EPA45	Angle	50 x 50 x 2200
Rastrel de Pino EPRPI	Pine joist R4	40 x 30 x 220 for every 3 lm
Rastrel WPC EPRWP	WPC joist	40 x 25 x 2200 for every 3 lm
Tornillo y Taco EPTT880	Screw & anchor	8 x 80 / 9 units
Clip Inox EPCLIP	SS clip hidden system	24 sets
Clip PVC Vista EPPVC	PVC clip at sight system	24 sets
Clip Inox Inicio EPCLI	SS start clip with screw	3 units
Clip Inox Inicio EPCLI	SS start clip with screw	3 units

En cada palet: 98,94 m<sup>2</sup> / 308 piezas. Por m<sup>2</sup>: 3,12 piezas de 2,2 ml

NDE Pool



## LINER PERSONALIZADO PERSONALISED LINERS



# LINER PERSONALIZADO PERSONALISED LINERS

## LINERS PARA PISCINAS DE ENSUEÑO

Transforme su piscina en un lugar único con diseños impresionantes.

La solución perfecta para maximizar el atractivo estético de su piscina.

La decoración perfecta para mejorar su piscina.

Coloque la marca de su empresa (usando logotipos y mascotas).

Perfecto para programas de educación y entretenimiento.

Nos adaptamos a sus necesidades.  
Solicitar presupuesto.



## LINERS FOR DREAM SWIMMING POOLS

*Turn your swimming pool into a unique area with breathtaking designs.*

*The perfect solution to maximise the aesthetic appeal of your pool zone and to impress your guests.*

*The perfect decoration to upgrade your swimming pool.*

*Unique design capabilities.*

*Supports company branding (using logos and mascots).*

*Perfect for educational and entertainment programs.*

*We adapt to your needs.*

*Please ask for a quotation.*





En NDE Wellness diseñamos y creamos espacio wellness tanto para su hotel, balneario o para su ambiente más íntimo.

Ofrecemos soluciones integrales que se adaptan a cada cliente, con el mejor servicio y estudiando la mejor propuesta para cada proyecto.

Nos adaptamos a sus necesidades.

Solicite presupuesto sin compromiso.

*At NDE Wellness we design and create wellness space for your hotel, spa or for your most intimate environment.*

*We offer integral solutions that adapt to each client, with the best service and studying the best proposal for each project.*

*We adapt to your needs.*

*Request a quote without commitment.*

## NDEWellness

---



NDEWELLNESS

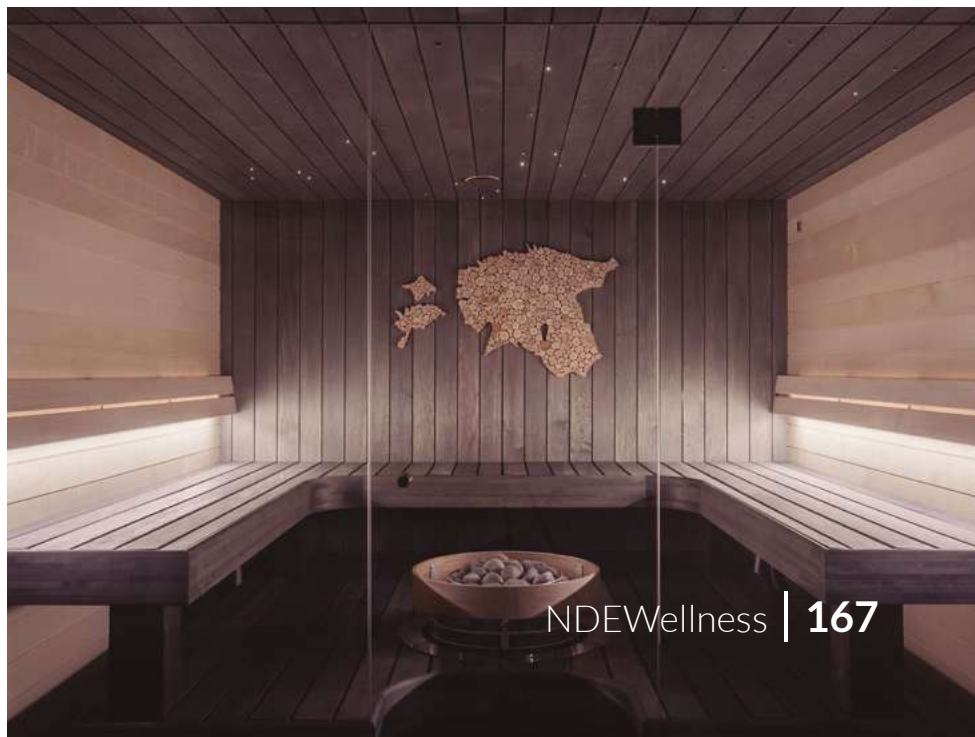





CENTROS DE WELLNESS A MEDIDA  
CUSTOMISED WELLNESS CENTERS



## CENTROS DE WELLNESS A MEDIDA CUSTOMISED WELLNESS CENTERS

### CONSTRUCCIÓN DE CENTROS DE WELLNESS DE FORMA MODULAR

Estructuras modulares fabricadas en EPS (**poliestireno expandido**), nos permite crear cualquier diseño o proyecto de spa, baño de vapor o zona wellness a medida de las necesidades y pretensiones de cada cliente.

Gracias a este innovativo sistema constructivo, contaremos con una mayor facilidad de instalación con los consiguientes ahorros de tiempo y dinero.

Se trata de estructuras muy ligeras pero también resistentes que facilitan enormemente su manipulación y ensamblaje.

Una vez que toda la estructura está ensamblada y sellada, es el momento de aplicar la impermeabilización y revestimiento elegidos.

Aunque existan módulos ya pre diseñados, es factible la realización de prácticamente cualquier proyecto.

### MODULAR CONSTRUCTION OF WELLNESS CENTERS

*Modular structures manufactured in EPS (**expanded polystyrene**), allow us to create any design or project of spa, steam bath or wellness area tailored to the needs and aspirations of each client.*

*Thanks to this innovative construction system, we will have a greater ease of installation with the consequent savings of time and money.*

*These are very light but also resistant structures that greatly facilitate handling and assembly.*

*Once the entire structure is assembled and sealed, it is time to apply the waterproofing and chosen surface.*

*Although there are modules already predesigned, it is feasible to carry out practically any project.*



## SAUNAS SAUNAS

La sauna Finlandesa o sauna seca de cabina y estufa, es un elemento esencial en un centro de spa. Sus beneficios sobre el organismo son abundantes y rápidos.

Nuestro portafolio de saunas, ofrece módulos de cabinas de diversas dimensiones e incluso podemos ajustarnos a sus necesidades.

Nos adaptamos a sus necesidades, solicitar presupuesto.

*The Finnish sauna or dry cabin sauna and stove, is an essential element in a spa center. Its benefits on the organism are abundant and fast.*

*Our portafolio of saunas offers, modules of cabins in different sizes and even we can adjust to your needs.*

*We adapt to your needs. Ask for a quotation.*

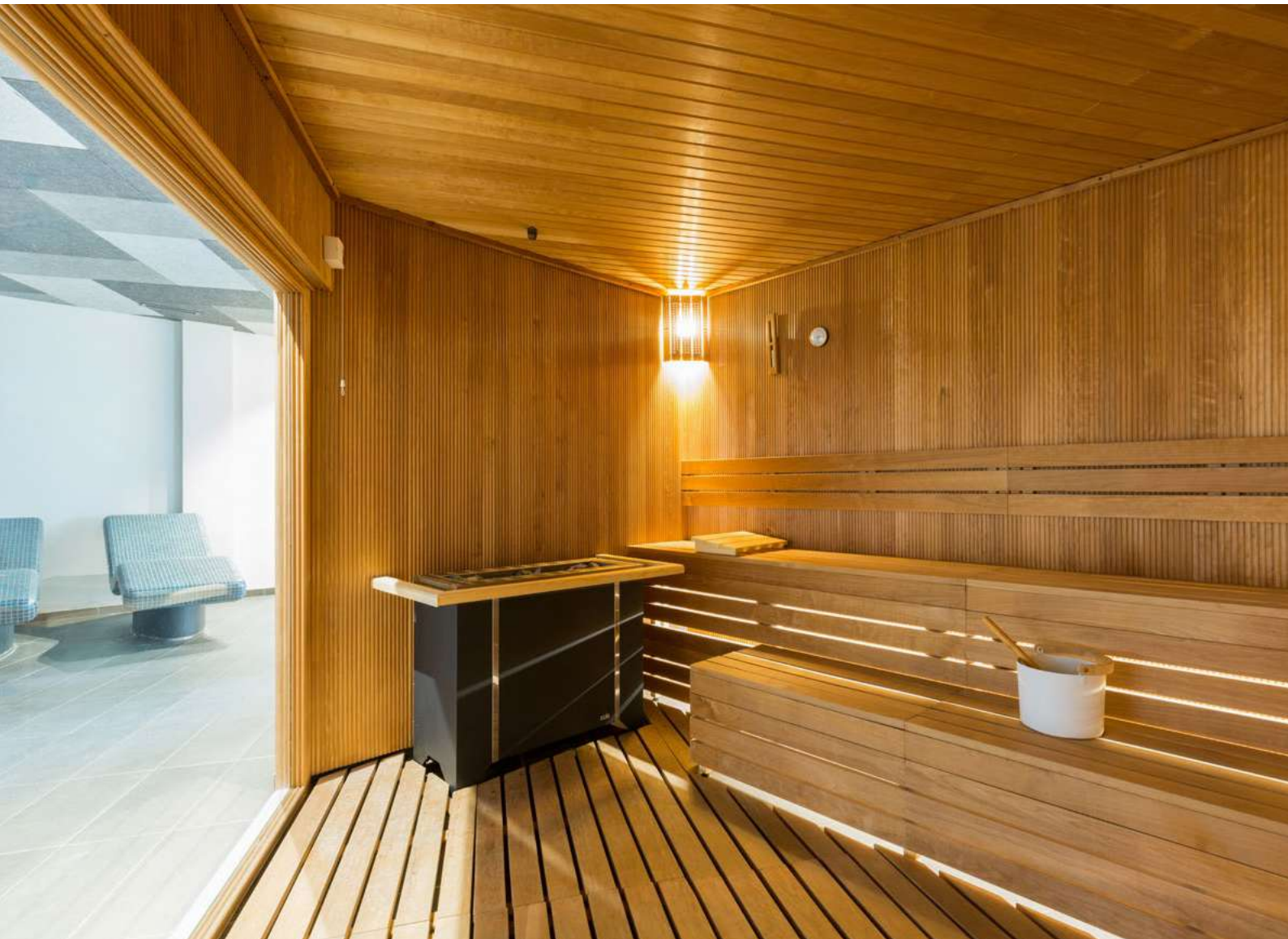



## FRIO Y CALOR HOT & COLD

### PERSONALIZAMOS SU CENTRO DE WELLNESS

- Baño de vapor
- Sauna Finlandesa
- Ducha de sensaciones
- Pediluvio
- Cabina de flotación
- Tumbona térmica
- Fuente de hielo

Todos estos son elementos que forman parte de un centro de wellness para conseguir una auténtica experiencia de bienestar, salud y relajación para el usuario.

NDE Group puede llevar su proyecto de wellness de principio a fin. Disponemos de soluciones adaptadas a cualquier diseño y necesidad.

Solicite presupuesto.

### WE CUSTOMISE YOUR WELLNESS CENTER

- Steam bath
- Finnish sauna
- Sensations shower
- Foot bath
- Flotation pool
- Thermal deckchair
- Ice fountain

*All these products are part of the wellness center in order to achieve an authentic experience of well-being, health and relaxation.*

*NDE Group carries your wellness project from scratch to the installation. We have the solutions for any kind of design and need.*

*Please ask for a quotation.*



## SPAS CON REBOSADERO OVERFLOW SPAS



### NDE-H1

Medidas (cm) <i>Measurements (cm)</i>	Ø 240 x 110
Asientos <i>Seat capacity</i>	6
Hidrojets <i>Hydrojets</i>	34
Jets de aire <i>Air jets</i>	12
Luz sub-acuática <i>Underwater light</i>	Standard
Sistema de control <i>Control system</i>	Balboa®
Calentador <i>Heater</i>	3 kW
Bombas de masaje <i>Massage pumps</i>	2 x 1.5hp
Bomba de aire <i>Nir pump</i>	400W
Bomba de recirculación <i>Circulation pump</i>	Standard
Ozonizador <i>Ozonator</i>	Standard
Cubierta térmica <i>Thermal cover</i>	Standard

Estos modelos de spa con rebosadero vienen equipados en dos modalidades:

Modalidad Standard, como un spa portátil incluido tanque de compensación, o Modalidad Kit Compacto (recomendado para hoteles) con filtro de arena, bombas de masaje, bomba de recirculación, resistencia de titanio, ozonizador y bomba soplante en un módulo separado al que habría que añadir un tanque de compensación. Consultar opcionales.

*These overflow spas comes equipped in two versions:*

*Standard Version, like a portable spa including water compensation tank, or Compact Kit Version (recommended for hotels) with a separate module with a sand filter, massage pumps, circulation pump, titanium heater, ozonator and air pump, to which you would need to add a water compensation tank. Please ask for optional extras.*

## SPAS DE HIDROMASAJE HOT TUBS



**NDE - 102**  
210 x 160 x 93 cm  
2 plazas  
24 jets de masaje  
17 jets de aire



**NDE - 705**  
210 x 210 x 90 cm  
5 plazas  
64 jets de masaje  
10 jets de aire



**NDE - 103**  
170 x 150 x 83 cm  
2 plazas  
23 jets de masaje



**NDE - 706**  
220 x 220 x 92 cm  
5 plazas  
58 jets de masaje  
12 jets de aire



**NDE - 104**  
210 x 210 x 83 cm  
5 plazas  
41 jets de masaje  
10 jets de aire



**NDE - 707**  
220 x 220 x 95 cm  
6 plazas  
94 jets de masaje  
18 jets de aire



**NDE - 105**  
Ø 180 x 93 cm  
5 plazas  
11 jets de masaje  
22 jets de aire



**NDE - 708**  
224 x 224 x 90 cm  
7 plazas  
67 jets de masaje  
14 jets de aire



**NDE - 106**  
220 x 210 x 93 cm  
6 plazas  
22 jets de masaje  
10 jets de aire



**NDE - 709**  
250 x 230 x 95 cm  
6 plazas  
94 jets de masaje  
22 jets de aire



**NDE - 701**  
210 x 160 x 79 cm  
3 plazas  
43 jets de masaje  
10 jets de aire

# SPAS DE HIDROMASAJE HOT TUBS



## EQUIPAMIENTO

Todos nuestros spas vienen equipados con:

- Sistema Balboa®
- Acrílicos de Aristech®
- Jets cromados
- Luz de fondo blanca
- Cromoterapia
- Ozonizador
- Bomba de recirculación 24h
- Resistencia de titanio
- Cubierta térmica

## EQUIPMENT

All our spas come equipped with:

- Balboa® system
- Aristech® acryl
- Chromed jets
- Underwater light
- Chromotherapy
- Ozonator
- 24 hr circulation pump
- Titanium heater
- Thermal cover

## REVESTIMIENTO CABINET



Coffee Woven Black



Grey Woven Brown



Woven Grey

## CUBIERTA COVER



Sand Brown Espresso

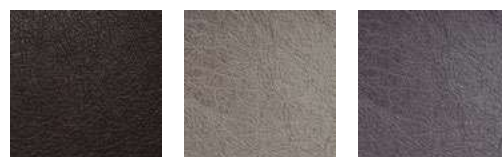

Black Light Grey Dark Grey



Woven Grey White

## COLORES COLOURS

Pure White Gypsum White Pearlescent White Silver Marble Oyster Opal Mayan Copper Midnight Opal Summer Sapphire





# OPCIONES OPTIONS

## FUSION STEREO

Sistema de música con altavoces empotrados y subwoofer. Conexión vía Bluetooth a su dispositivo móvil.

*Music system with in built speakers and subwoofer. Connection via Bluetooth to your mobile device.*



Escaleras de dos peldaños  
*Steps, 2 tiers*



Sistema TV 19" o 32"  
*TV system 19" or 32"*



Cascada iluminada  
*Lit cascade*



Almohadilla con cascada  
*Headrest with cascade*

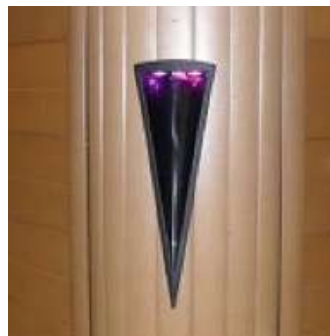

Iluminación esquinas  
*Corner lights*



Jets Fountain  
*Fountain jets*



Jets iluminados  
*Lit jets*



App & receptor WiFi  
*WiFi with app*



Eleva cubiertas  
*Cover lifter*



# SWIMSPAS



NDE-1300  
466x230x155  
3 plazas  
53 jets de masaje



NDE-1201  
580x225x156  
3 plazas  
32 jets de masaje  
6 jets de aire



NDE-1000  
580x225x156  
2+1 plazas  
53 jets de masaje

Swimspas desde 3.98m hasta 7.90m de longitud  
Swimspas from 3.98m to 7.90m length



Tenemos más de una decena de modelos de swimspas e infinity pools en acrílico Aristech® White Silver Marble. Nuestros swimspas vienen en dos modalidades de nadador contracorriente: 3 potentes jets con velocidad del agua ajustable o con turbina extra potente con mando a distancia.

Todos nuestros swimspas incluyen cubierta térmica.

Disponible con múltiples opciones.

Además disponemos de equipamiento para fitness acuático.

Solicite catálogo completo.

*We have more than a dozen models of swimspas and infinity pools in Aristech® White Silver Marble acrylic. Our swimspas come in two types of countercurrent swimming elements: 3 powerful jets with adjustable water speed or with extra powerful turbine with remote control.*

*All our swimspas include thermal cover.*

*Available with multiple options.*

*We also have equipment for aquatic fitness.*

*Please ask for full catalogue.*

JUEGOS DE AGUA INOX  
STAINLESS STEEL WATER FEATURES

## JUEGOS DE AGUA INOX STAINLESS STEEL WATER FEATURES

### COMPLEMENTOS PARA SPAS Y PISCINAS

Nuestro extensivo catálogo de productos incluye una gran gama de diferentes diseños y tamaños de cascadas, fuentes, chorros, cortinas de agua y cañones que se ajustan a cualquier ambiente y forman un atractivo añadido tanto estético como funcional.

### COMPLEMENTS FOR SPAS AND POOLS

*Our extensive catalogue of products includes a wide range of different designs and sizes of waterfalls, fountains, jets, water curtains and cannons that adjust to any environment and form an added aesthetic and functional appeal.*



# CASCADAS WATER CURTAINS

AIISI 316L

## CASCADA BAL WATER CURTAIN BAL

Optional: Luz LED  
Optional: LED light

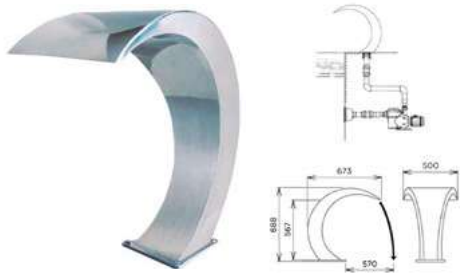

Code	DESCRIPTION
WF87185047	Brillo <i>Polished</i>
WF87185054	Satinado <i>Brush polished</i>
WF87185050	Brillo A316 electropulido <i>Polished electropolished</i>

Code	DESCRIPTION
WF87185062	Anclaje rosca hembra conexión 2" <i>Anchorage Female connection 2"</i>

Code	DESCRIPTION
WF87185048	Embelledor brillo <i>Escutcheon polished</i>
WF87185055	Embelledor satinado <i>Escutcheon brush polished</i>

Caudal 30 m<sup>3</sup>/h  
Flow: 30 m<sup>3</sup>/h  
Bomba recomendada 1.5 kW  
Recommended pump: 1.5 kW

Anclaje no incluido *Anchorage not included*

## CASCADA MAU WATER CURTAIN MAU

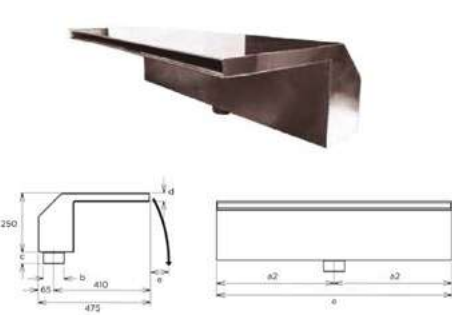

## CASCADA IGU WATER CURTAIN IGU



Code	a	b	c	d	e
WF87186061	300	2"	42	25	270
WF87186060	500	2"	42	25	250
WF87186065	1000	3"	48	35	260

Code	DESCRIPTION
WF87186067	Brillo <i>Polished</i>
WF87186077	Electropulido <i>Brush polished</i>

b=rosca hembra *b=female connection*  
Caudal: 10 m<sup>3</sup>/h (300mm), 20 m<sup>3</sup>/h (500mm), 40 m<sup>3</sup>/h (1000mm)  
Flow: 10 m<sup>3</sup>/h (300mm), 20 m<sup>3</sup>/h (500mm), 40 m<sup>3</sup>/h (1000mm)  
Bomba recomendada: 0.33 kW (300mm), 0.55 kW (500mm), 2.2 kW (1000mm)  
Recommended pump: 0.33 kW (300mm), 0.55 kW (500mm), 2.2 kW (1000mm)

BRILLO *POLISHED*:  
Incl. embelendedor *Incl. escutcheon*: WF87100979  
Incl. anclaje *Incl. anchor*  
Rosca hembra *Female connection*: 1 1/2"  
Caudal *Flow*: 35 m<sup>3</sup>/h  
Bomba recomendada *Recommended pump*: 2.2 kW

# CASCADAS Y CAÑONES

## CURTAINS AND CANNONS

### CASCADA MINI BAL

#### WATER CURTAIN MINI BAL



Code	DESCRIPTION
WF87185041	AIS1304L
WF87185044	AIS1316L
WF87185060	Electropulido <i>Electropolished</i>

Anclaje no incluido *Anchorage not included*



Code	DESCRIPTION
WF87185043	Anclaje MINI BAL rosca hembra conexión 2" <i>Anchorage MINI BAL Female connection 2"</i>

Rosca hembra *Female connection: 1 1/2"*  
Caudal 20 m<sup>3</sup>/h *Flow: 20 m<sup>3</sup>/h*  
Bomba recomendada 0.75 kW  
*Recommended pump: 0.75 kW*

### CAÑÓN CIRCULAR CAP

#### CANNON JET CIRCULAR CAP



Code	DESCRIPTION
WF87186030	Boquilla circular <i>Circular nozzle</i>

Incl. embellecedor y anclaje  
*Incl. escutcheon and anchorage*  
Rosca hembra 2 1/2" *Female connection 2 1/2"*  
Caudal 20 m<sup>3</sup>/h *Flow: 20 m<sup>3</sup>/h*  
Bomba recomendada: 1 kW  
*Recommended pump: 1 kW*

### CASCADA VIC

#### WATER CURTAIN VIC

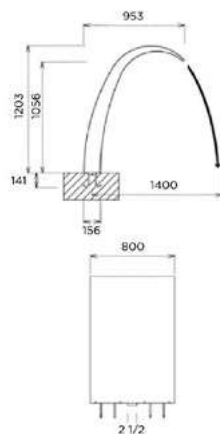

Code	DESCRIPTION
WF87186064	Cascada <i>Water curtain</i>

Incl. anclaje *Incl. anchor*  
Rosca hembra: 2 1/2" *Female connection: 2 1/2"*  
Caudal: 50 m<sup>3</sup>/h *Flow: 50 m<sup>3</sup>/h*  
Bomba recomendada: 2.2 kW *Recommended pump: 2.2 kW*

### CAÑÓN PLANO CAP

#### CANNON FLAT CAP



Code	DESCRIPTION
WF87186031	Boquilla plana <i>Flat nozzle</i>

Incl. embellecedor y anclaje *Incl. escutcheon and anchor*  
Rosca hembra: 2 1/2" *Female connection: 2 1/2"*  
Caudal: 22 m<sup>3</sup>/h *Flow: 22 m<sup>3</sup>/h*  
Bomba recomendada: 1 kW *Recommended pump: 1 kW*

# CAÑONES CANNONS

AIISI 316L

## CAÑÓN CIRCULAR FID CIRCULAR WATER CURTAIN FID



Code	DESCRIPTION
WF87185014	Brillo <i>Polished</i>
WF87185015	Satinado <i>Brush polished</i>

Anclaje no incluido *Anchorage not included: WF87185039*  
 Conexión: : 2" *Connection: 2"*  
 Caudal: 8 m<sup>3</sup>/h *Flow: 8 m3/h*  
 Bomba recomendada: 0.5 kW *Recommended pump: 0.5 kW*

## ANCLAJE FID ANCHORAGE FID

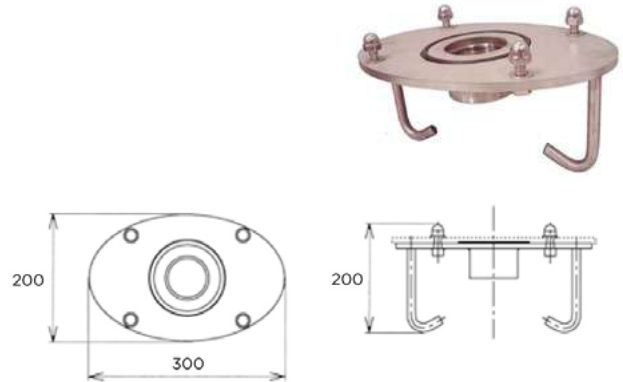

Code	DESCRIPTION
WF87185039	Anclaje rosca hembra conexión 2" <i>Anchorage female connection 2"</i>

## CAÑÓN PLANO FID FLAT CANNON FID



Code	DESCRIPTION
WF87185022	Brillo <i>Polished</i>
WF87185023	Satinado <i>Brush polished</i>

Anclaje no incluido *Anchorage not included: WF87185039*  
 Conexión: : 2" *Connection: 2"*  
 Caudal: 8 m<sup>3</sup>/h *Flow: 8 m3/h*  
 Bomba recomendada: 0.5 kW *Recommended pump: 0.5 kW*

## CAÑÓN PLANO TAH FLAT CANNON TAH

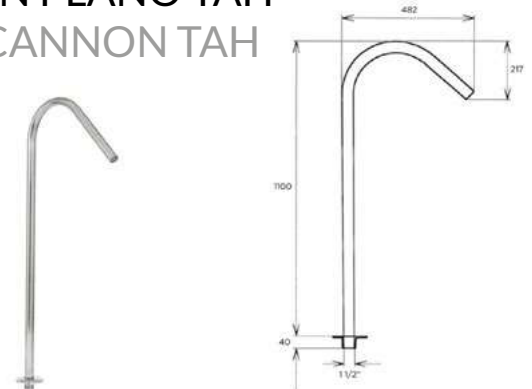

Code	DESCRIPTION
WF87187010	Cañón <i>Cannon</i>

No es necesario anclaje *No anchorage needed*  
 Rosca macho: 1 1/2" *Male connection: 1 1/2"*  
 Caudal: 6 m<sup>3</sup>/h *Flow: 6 m3/h*  
 Bomba recomendada: 0.33 kW *Recommended pump: 0.33 kW*  
 No incluye boquilla 4 *Nozzle 4 not included*

# BOQUILLAS PARA CAÑÓN TAH NOZZLES FOR CANNON TAH

AISI 316L

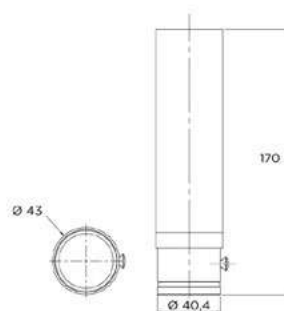

Code	DESCRIPTION
WF87187014	Boquilla 1 <i>Nozzle 1</i>

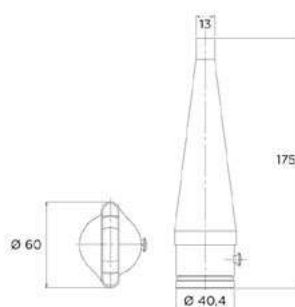

Code	DESCRIPTION
WF87187012	Boquilla 2 <i>Nozzle 2</i>

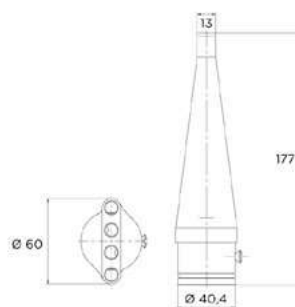

Code	DESCRIPTION
WF87187011	Boquilla 3 <i>Nozzle 3</i>

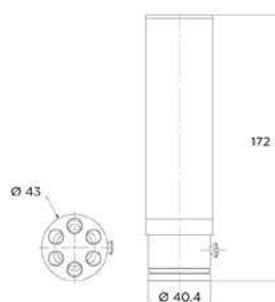

Code	DESCRIPTION
WF87187013	Boquilla 4 <i>Nozzle 4</i>



# BOQUILLAS NOZZLES

AISI 316L

## BOQUILLA ASPIRACIÓN ANTIVORTEX ANTIVORTEX SUCTION INLET

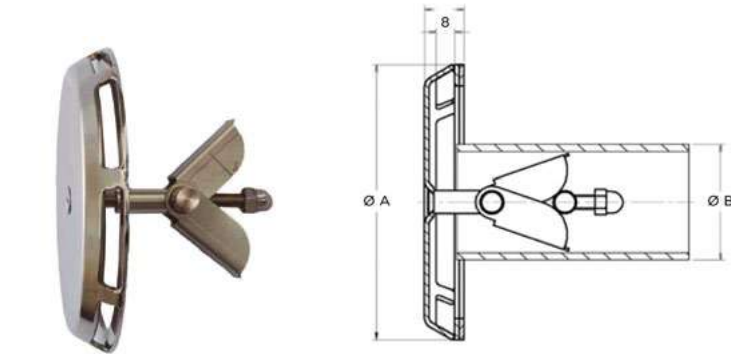

Code	m <sup>3</sup> /h	a	b
WF87198035	15	120	50-63
WF87198036	25	165	50-63

Para liner y poliéster *For liner and polyester*

Code	m <sup>3</sup> /h	a	b
WF87198032	15	120	50-63
WF87198033	25	165	50-63
WF87198034	40	240	63-75

Para hormigón *For concrete*

## BOQUILLA EMPOTRABLE CIRCULAR CIRCULAR NOZZLE TO BE FITTED

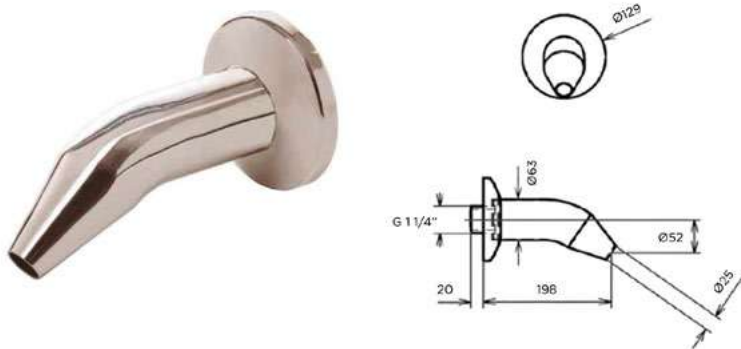

Code	DESCRIPTION
WF87188010	<i>Circular nozzle to be fitted</i>

Rosca macho: 1 1/4" *Male connection: 1 1/4"*  
 Caudal: 12 m<sup>3</sup>/h *Flow: 12 m<sup>3</sup>/h*  
 Bomba recomendada: 0.55 kW  
*Recommended pump: 0.55 kW*

## BOQUILLA EMPOTRABLE PLANA FLAT NOZZLE TO BE FITTED

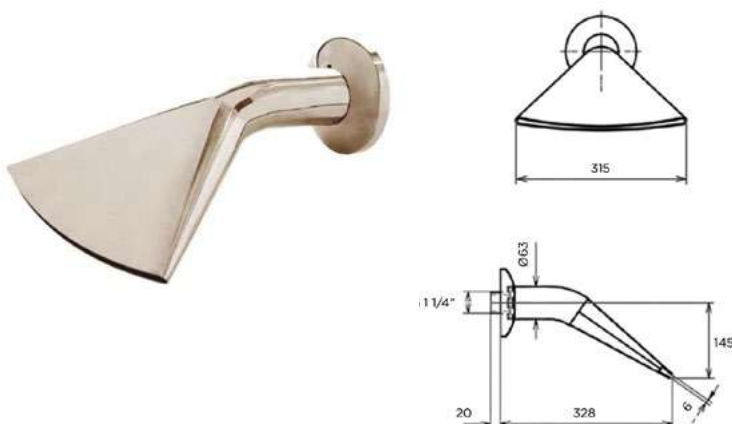

Code	DESCRIPTION
WF87188011	<i>Flat nozzle to be fitted</i>

Rosca macho: 1 1/4" *Male connection: 1 1/4"*  
 Caudal: 20 m<sup>3</sup>/h *Flow: 20 m<sup>3</sup>/h*  
 Bomba recomendada: 0.55 kW  
*Recommended pump: 0.55 kW*

# FUENTES FOUNTAINS

AISI 316L

## FUENTE SOMBRILLA NIA FOUNTAIN NIA TOP

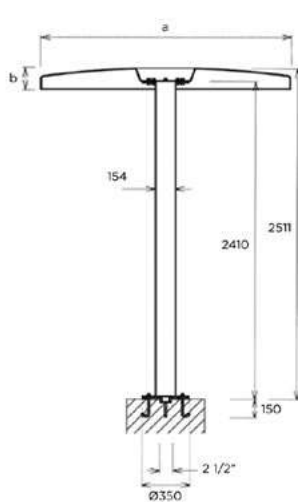

Code	a	b	DESCRIPTION
WF87186072	1700	200	Rojo Polyester red
WF87186074	1700	200	Blanco Polyester white
WF87186071	Columna Column		

Incluye anclaje *Anchorage included*  
 Rosca hembra: 2 1/2" *Female connection: 2 1/2"*  
 Caudal: 34 m<sup>3</sup>/h *Flow: 34 m<sup>3</sup>/h*  
 Bomba recomendada: 2.2 kW *Recommended pump: 2.2 kW*

## FUENTE PAL PAL FOUNTAIN

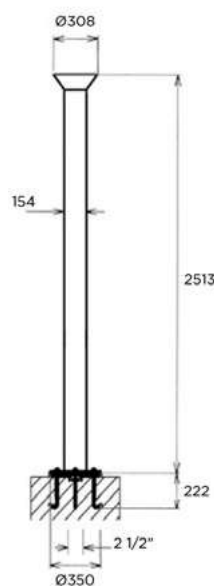

Code	DESCRIPTION
WF87186073	Palm Fountain

Incluye anclaje *Anchorage included*  
 Rosca hembra: 2 1/2" *Female connection: 2 1/2"*  
 Caudal: 35 m<sup>3</sup>/h *Flow: 35 m<sup>3</sup>/h*  
 Bomba recomendada: 2.2 kW *Recommended pump: 2.2 kW*

# TUMBNAS AIR BEDS

AISI 316L

## TUMBONA HIDROMASAJE AIR BED



Code	DESCRIPTION
------	-------------

WF87191010 Air bed

132 orificios Ø2,5mm 132 orifices Ø2,5 mm  
 Única toma de aire en la base An only intake on the base  
 Instalación con soporte base: WF87191010 + (WF87191011 ó WF87191013 ó WF87191014) + 87100014  
 Installation with base support: WF87191010 + (WF87191011 or WF87191013 or WF87191014) + 87100014  
 Para empotrar: WF87191010 + WF87191012  
 To build in: WF87191010 + WF87191012  
 Rosca hembra: 1/2" G Female connection: 1/2" G  
 Caudal: 145 m³/h Flow: 145 m³/h  
 Accesorios no incluidos Accessories not included

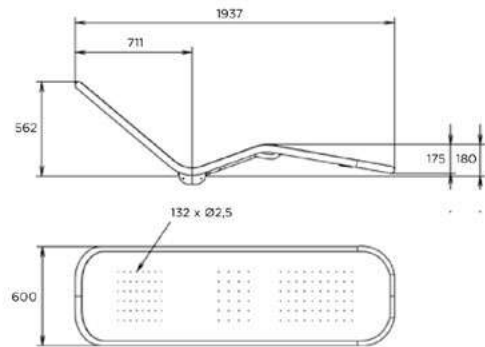

## TUMBONA HIDROMASAJE EMPOTRABLE AIR BED TO BUILD IN

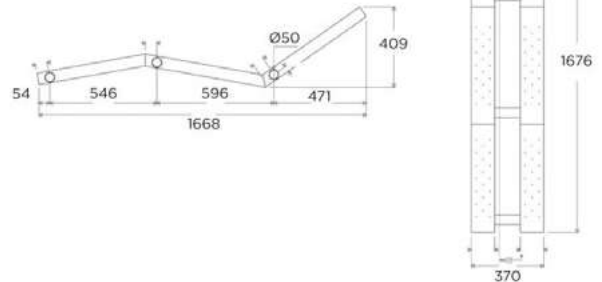
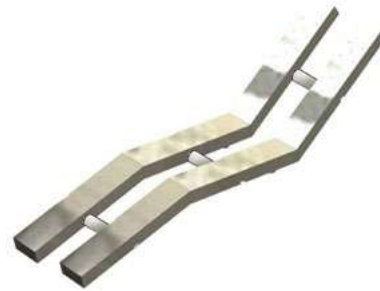
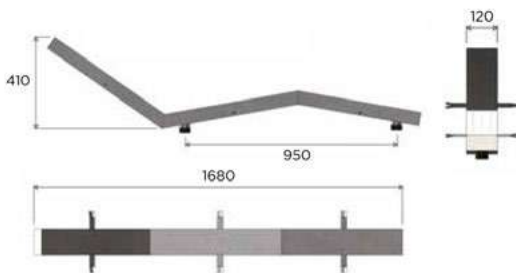

Code	DESCRIPTION
------	-------------

WF87191021 Air bed to build in

Accesorios no incluidos Accessories not included

Code	DESCRIPTION
------	-------------

WF87191022 Air bed to build in

## PULSADORES PUSH BUTTONS

AISI 316L

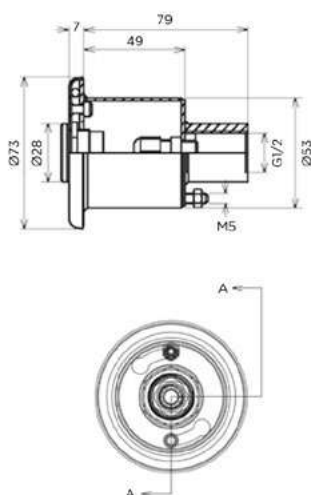
PULSADOR PIEZOELECTRÓNICO INOX  
STAINLESS STEEL ELECTRONIC PUSHBUTTON SWITCH

Code	Ø	Height	DESCRIPTION
WF87100985	73	82,5	Pushbutton LED A-316L
WF87189085	Control System LED pushbutton		

Sin tornillos *Screwless*Tensión: 1-24V AC/DC *Tension: 1-24V AC/DC*Corriente: 0.200 A *Current: 0.200 A*

Temperatura de funcionamiento y almacenaje: -40°C to +125°C

*Operating and storage temperature: -40°C to +125°C*

Sistema de control de 2 salidas PCSMA opcional: WF87189085

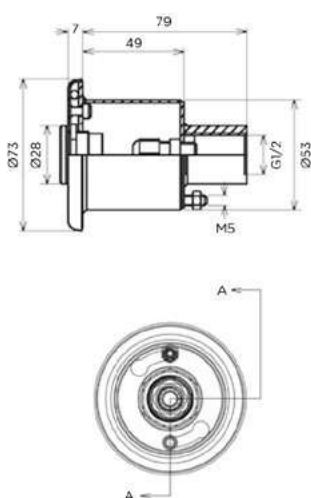
*Optional control system 2 outputs PCSMA: WF87189085*IP68 - puede ir sumergido IP68 - *Waterproof*PULSADOR PIEZOELECTRÓNICO INOX  
ELECTRONIC PUSHBUTTON SWITCH

Code	Ø	Height	DESCRIPTION
WF87100975	73	82,5	Pushbutton LED B-316L
WF87189080	Control System LED pushbutton		

Sin tornillos *Screwless*Tensión: 1-24VAC/DC *Tension: 1-24VAC/DC*Corriente: 0.200 A *Current: 0.200 A*

Temperatura de funcionamiento y almacenaje: -40°C to +125°C

*Operating and storage temperature: -40°C to +125°C*

Sistema de control de 1 salida PCSMA opcional: WF87189085

*Optional control system 1 output PCSMA: WF87189085*IP68 - puede ir sumergido IP68 - *Waterproof*

# ACCESORIOS ACCESSORIES

AISI 316L

## ANCLAJE ANCHORAGE

Code	DESCRIPTION
------	-------------

WF87100014 Anchorage

Para hormigón y liner *For concrete and liner*

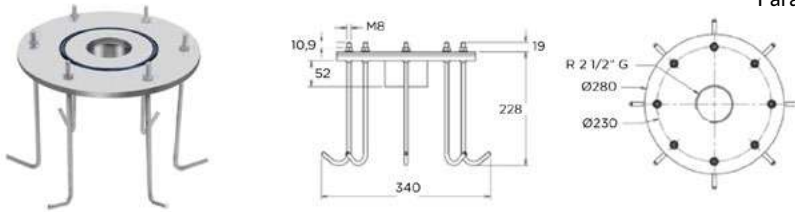

## ANCLAJE PARA EMPOTRAR ANCHORAGE TO BUILD IN

Code	DESCRIPTION
------	-------------

WF87191012 Anchorage to build in

Para hormigón y liner *For concrete and liner*

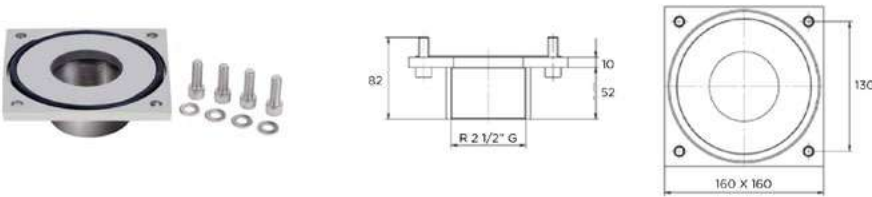

## SOPORTE BASE BASE SUPPORT

Code	a	DESCRIPTION
------	---	-------------

WF87191013 150 Base support

WF87191011 200 Base support

WF87191014 450 Base support



## APOYABRAZOS ARMREST

Code	U	DESCRIPTION
------	---	-------------

WF87191017 x1 Armrest



# VARIOS VARIOUS

AISI 316L

## SUMIDERO INOX MAIN DRAIN BOX

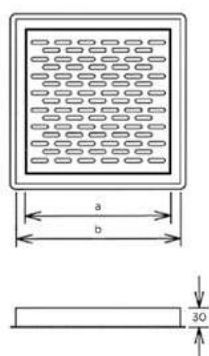

Code	a	b
WF87198012	205	252
WF87198013	285	332
WF87198015	460	477

## CAJÓN DE MASAJE POR AIRE MASSAGE PLATE BY AIR

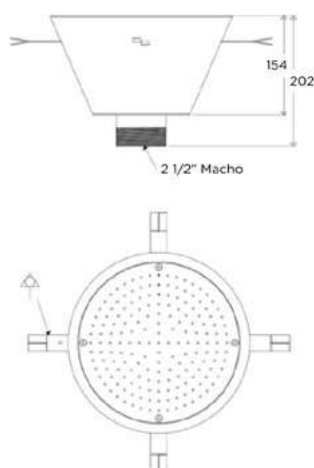

Code	Ø	Flow	Blower
WF87188020	300mm	140m <sup>3</sup> /h	0,85 kW
WF87188021	500mm	180m <sup>3</sup> /h	1,3 kW
WF87188022	700mm	216m <sup>3</sup> /h	1,6 kW

Para hormigón *For concrete*

Code	Ø	Flow	Blower
WF87188040	300mm	140m <sup>3</sup> /h	0,85 kW
WF87188041	500mm	180m <sup>3</sup> /h	1,3 kW
WF87188042	700mm	216m <sup>3</sup> /h	1,6 kW

Para liner y poliéster *For liner and polyester*

## CAJÓN DE MASAJE POR AIRE MASSAGE PLATE BY AIR

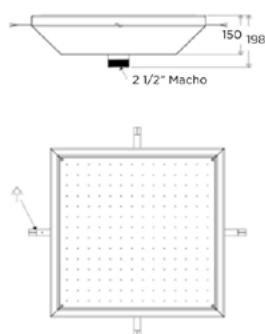

Code	Ø	Flow	Blower
WF87188023	350x350	180m <sup>3</sup> /h	1,3 kW
WF87188024	650x650	216m <sup>3</sup> /h	1,6 kW

Para hormigón *For concrete*

Code	Ø	Flow	Blower
WF87188043	350x350	180m <sup>3</sup> /h	1,3 kW
WF87188044	650x650	216m <sup>3</sup> /h	1,6 kW

Para liner y poliéster *For liner and polyester*

## VESTUARIOS CHANGING ROOMS

### IMPRESINDIBLES EN CUALQUIER CENTRO DEPORTIVO

Equipamos de forma integral una parte tan importante dentro de cualquier centro como son las salas de aseo y vestuario. El material con el que se suministran las taquillas, divisiones de ducha, puertas y bancos de vestuario, en cualquier tipo o versión, es de compacto de resinas fenólicas termoendurecidas, material de gran dureza y resistencia a la humedad, complementando los mismos con herrajes de fijación, abertura y cierre fabricados en acero inoxidable de alta calidad, lo que garantiza su larga vida en instalaciones de uso profesional. Solicite presupuesto sin compromiso.

### ESSENTIAL IN EVERYSPORTS CENTER

*We fully equip such important parts of any center as are the shower and dressing rooms.*

*The material with which the lockers, shower divisions, doors and benches are supplied, in any type or version, is made of compact thermo-hardened phenolic resins, material of great hardness and resistance to humidity, complementing them with fittings, opening and closing made of high quality stainless steel, which guarantees its long life in installations for professional use.*

*Please ask for our catalogue.*







## GIMNASIO GYM



### EQUIPAMIENTO PARA GIMNASIOS

Ofrecemos soluciones integrales que se adaptan a la tipología de cada cliente, ofreciendo el mejor servicio y estudiando la mejor propuesta para cada proyecto e incluso si fuese de interés personalizamos el producto, lo que nos permite soluciones exclusivas, obteniendo que cada proyecto tenga identidad propia.

Nuestra cartera de producto abarca una amplia gama de maquinaria fitness, cardio y de rehabilitación para el entrenamiento profesional y doméstico, capaz de cubrir la necesidad de nuestros clientes.

Si nos facilita el espacio que quiere dedicar a la zona Gym, nosotros le diseñaremos distintos circuitos adaptados a cada necesidad.

Infórmese y pida nuestros catálogos.

### GYM EQUIPMENT

*We offer integral solutions that adapt to the typology of each client, offering the best service and studying the best proposal for each project. Even if it is of interest we customise the product, which allows us exclusive solutions, obtaining that each project has its own identity. Our product portfolio covers a wide range of fitness, cardio and rehabilitation machinery for professional and domestic training, capable of meeting the needs of our clients.*

*If you provide us with the space you want to dedicate to the Gym area, we will design different circuits adapted to each need.*

*Please ask for our catalogues.*



Hacemos su proyecto a medida, díganos el espacio que tiene y para qué tipo de cliente es y nosotros le diseñaremos un gimnasio de última generación. Solicite presupuesto sin compromiso.

*We customise your project, tell us the space you have and for what type of customer it is and we will design a state-of-the-art gym. Please ask us for a quotation.*

## GIMNASIO GYM





Solicitar presupuesto sin compromiso.  
*Please ask for our catalogue.*

NDE Play se dedica a todo tipo de instalaciones para parques temáticos, acuáticos, infantiles y equipamiento para gimnasios al aire libre.

Para ver más productos rogamos soliciten nuestro catálogo completo.

*NDE Play is dedicated to all types of installations for theme parks, water parks, play grounds and equipment for outdoor gyms.*

*To see more of our range of products, please ask us for our full catalogue.*





## PARQUES ACUÁTICOS WATER PARKS

### MAQUINARIA, DISEÑO Y MÓDULOS

Creamos soluciones de ocio y entretenimiento en el agua, con y sin profundidad, adaptándonos a todas las edades y necesidades, tanto con opciones en interior como al exterior, desde hoteles, clubs, campings, apartamentos, comunidades, piscinas públicas, zonas splash, hasta parques acuáticos.

Ofrecemos soluciones individuales y personalizadas, con exclusividad para cada proyecto, nuestro objetivo principal es transformar las ideas de nuestros clientes en realidad y que la inversión sea lo mas rentable posible.

Solicite presupuesto sin compromiso.



### MACHINERY, DESIGN & MODULES

*We create leisure solutions for water entertainment, for pools with and without depth. Adapted to all ages and needs, both indoor and outdoor options. From hotels, clubs, campings, apartments, communities, public pools, splash spaces, to even water parks.*

*We offer individual and customised solutions, with exclusivity for each project. Our main objective is to transform the ideas of our clients into reality and make the investment as profitable as possible.*

*Please ask us for a quotation.*

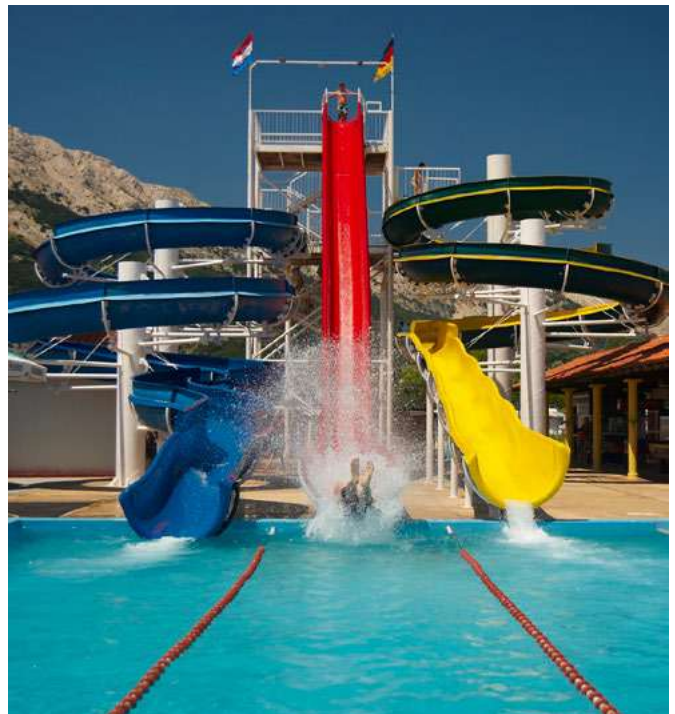





## PARQUES ACUÁTICOS WATER PARKS

Solicitar presupuesto sin compromiso.  
*Please ask for our catalogue.*



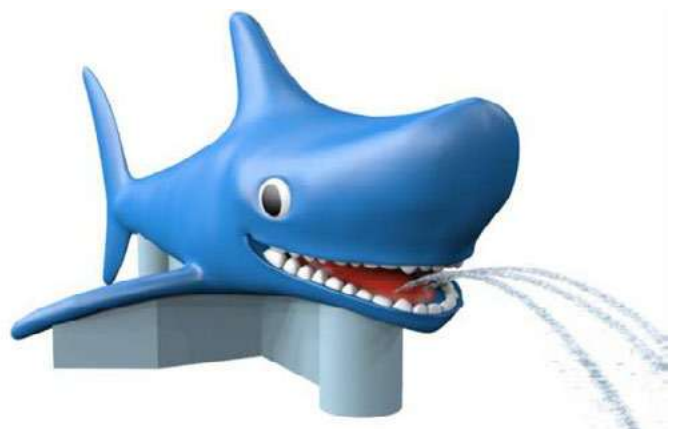
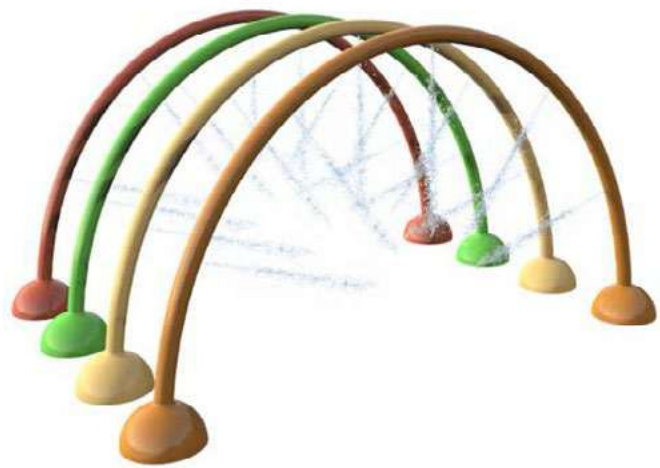

# PARQUES TEMÁTICOS THEME PARKS

## TEMATIZACIÓN PARA PARQUES TEMÁTICOS

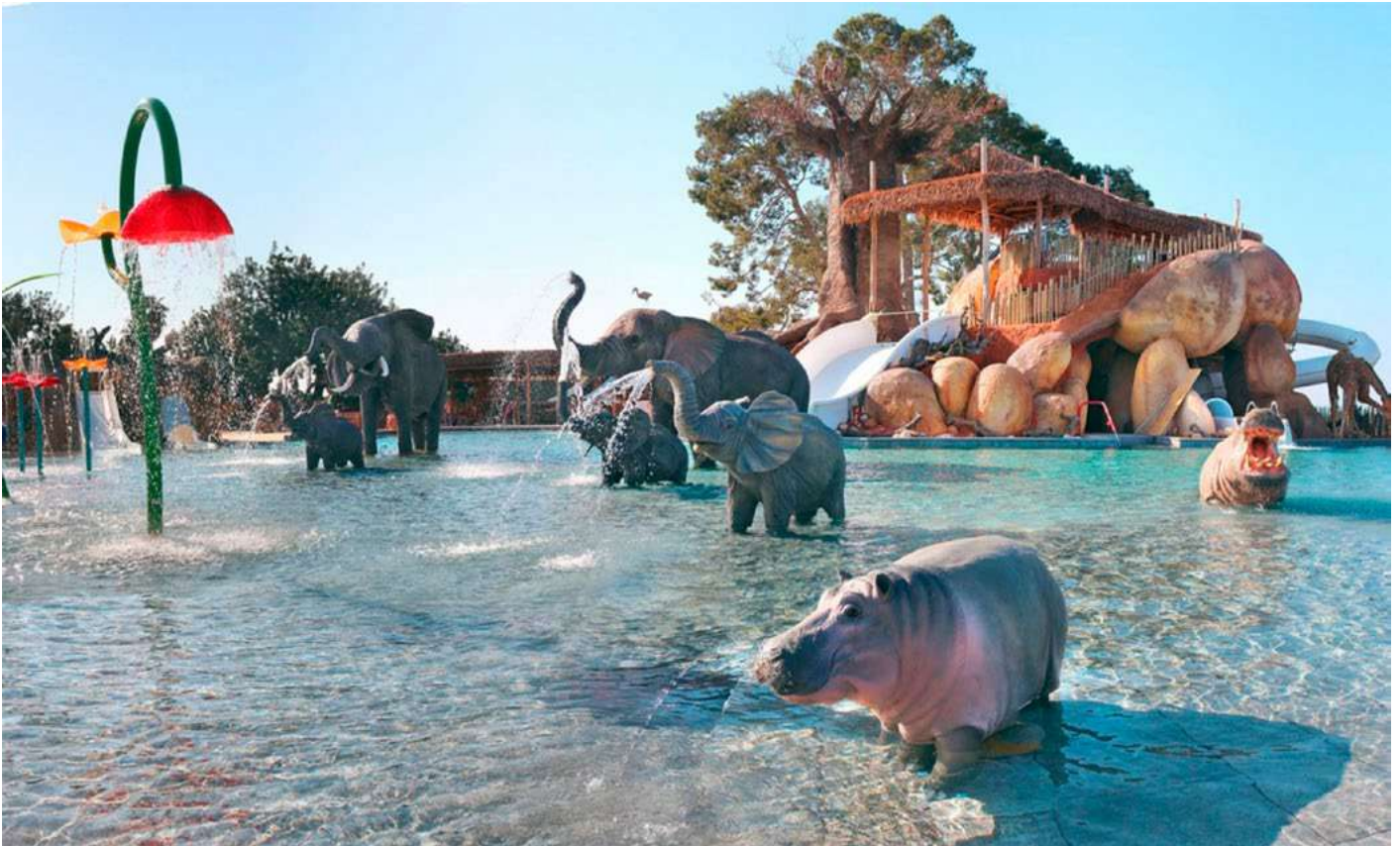

NDE Group le ayudará a diseñar el parque de sus sueños. La tematización consiste en ambientar un espacio, ya sea en parques acuáticos, hotel o una piscina, incorporando figuras personalizadas que en su conjunto creen una temática.

Con el fin de desarrollar la idea de nuestros clientes, le ofrecemos el asesoramiento de nuestros departamentos de diseño o técnicos y de toda su experiencia, en la proyección de ambientes. Hacemos realidad su idea, figura, logo, elementos y accesorios estándares y personalizados de acuerdo a sus necesidades.

Consulte su proyecto con nosotros.

*NDE Group will help you to design the park of your dreams. The theming consists of setting a space, like for instance an aquatic park, hotel or swimming pool, adding customised figures that all together create a theme.*

*In order to develop the idea of our clients, we offer the advice of our design or technical departments and of all their experience in the design of environments. We make your idea, figure, logo, elements and standard and customised accessories according to your needs.*

*Consult your project with us.*

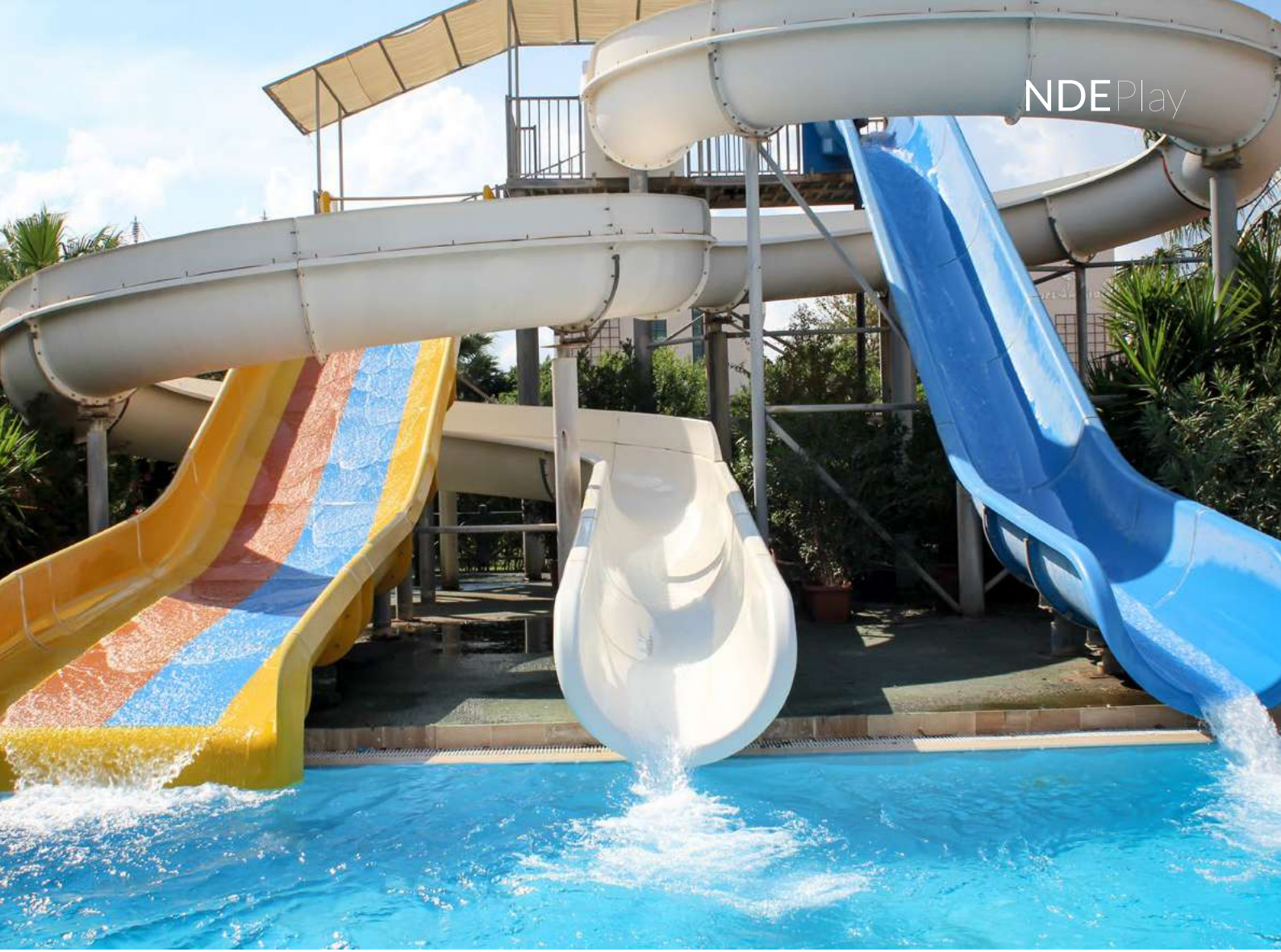



NDE México  
Complejo Lobby 33, Guadalajara.  
Piscina 25 x 4 x 1,5m con chapa de acero galvanizado en piso 26 del edificio.



NDE Project está formado por un equipo de ingenieros, arquitectos, aparejadores y diseñadores, que se dedican a llevar a cabo el proyecto desde el primer borrador hasta su ejecución, ofreciendo a nuestros clientes un único interlocutor y proveedor.

Nuestro principal mercado es tanto nacional como internacional, principalmente en Europa y América Latina. De esta manera, podemos ofrecer una gestión de servicios integral a nivel global.

*NDE Project is a team of engineers, architects and designers, who are dedicated to carrying out the project from the first draft to its execution, offering our clients a single supplier.*

*Our main markets are both national and international, mainly in Europe and Latin America. This way we can offer comprehensive service management at global level.*

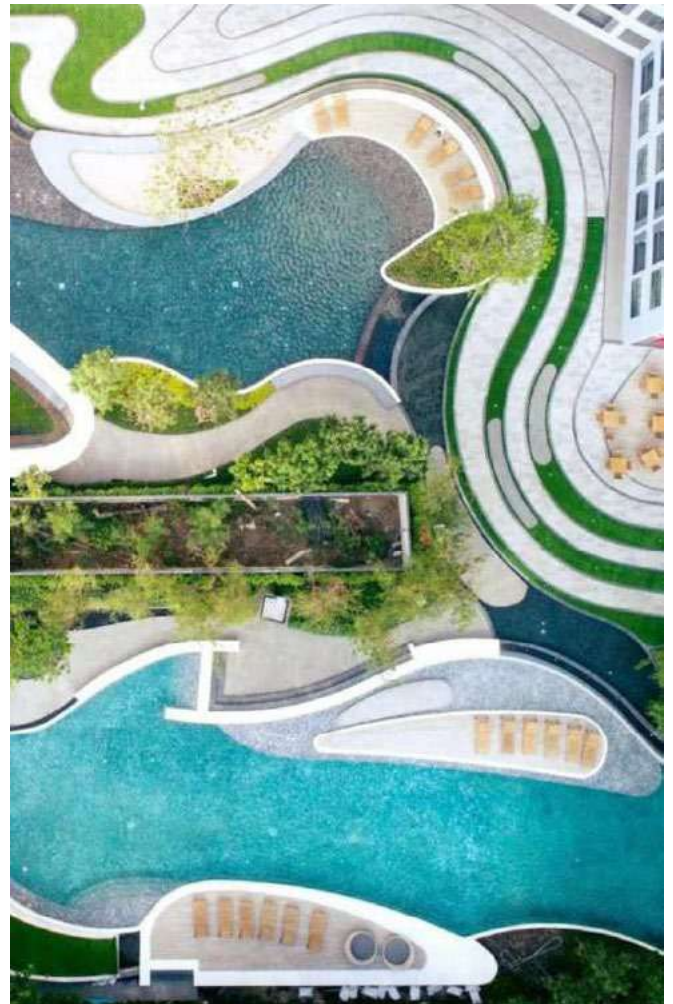



MUNICIPAL POOL ACIDALIO LORENZO, SANTA CRUZ DE TENERIFE, CANARY ISLANDS, SPAIN



PISCINA COMUNITARIA, SANT CUGAT DEL VALLÉS, BARCELONA, SPAIN



PISCINAS JACUZZI, BAJA CALIFORNIA, MÉXICO



25x16,67m, BARCELONA, SPAIN





25x2 LOS CABOS, BAJA CALIFORNIA, MÉXICO

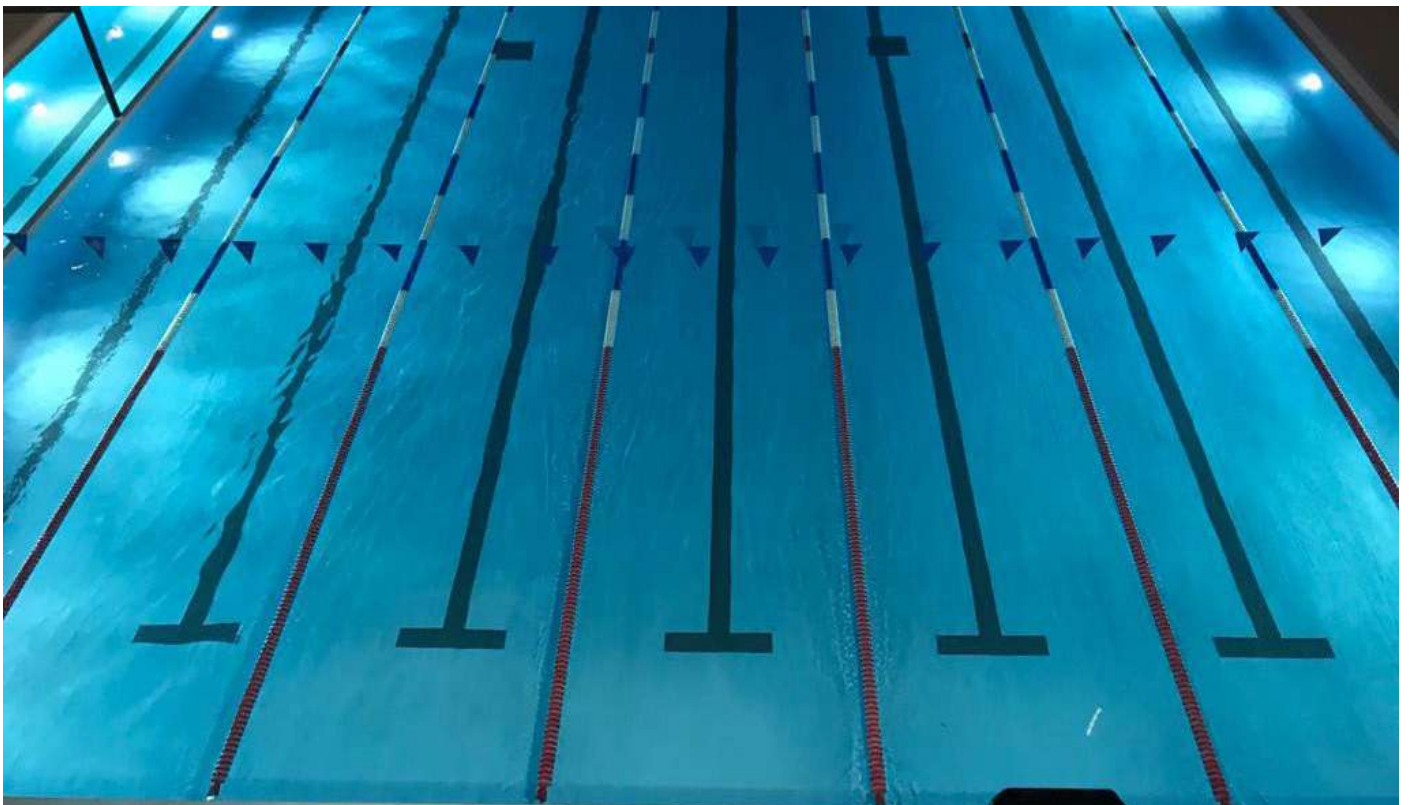

BLUE LANE, SAN JOSE LOS CABOS, MÉXICO



CLUB ESPAÑA, MÉXICO DF



ISLOTE DEL AMOR, LANZAROTE, SPAIN



CLUB DE TENNIS LA BISBAL, BARCELONA



CLUB DE TENNIS LA BISBAL, SAUNAS, BARCELONA



HOTEL MYND YAIZA, LANZAROTE

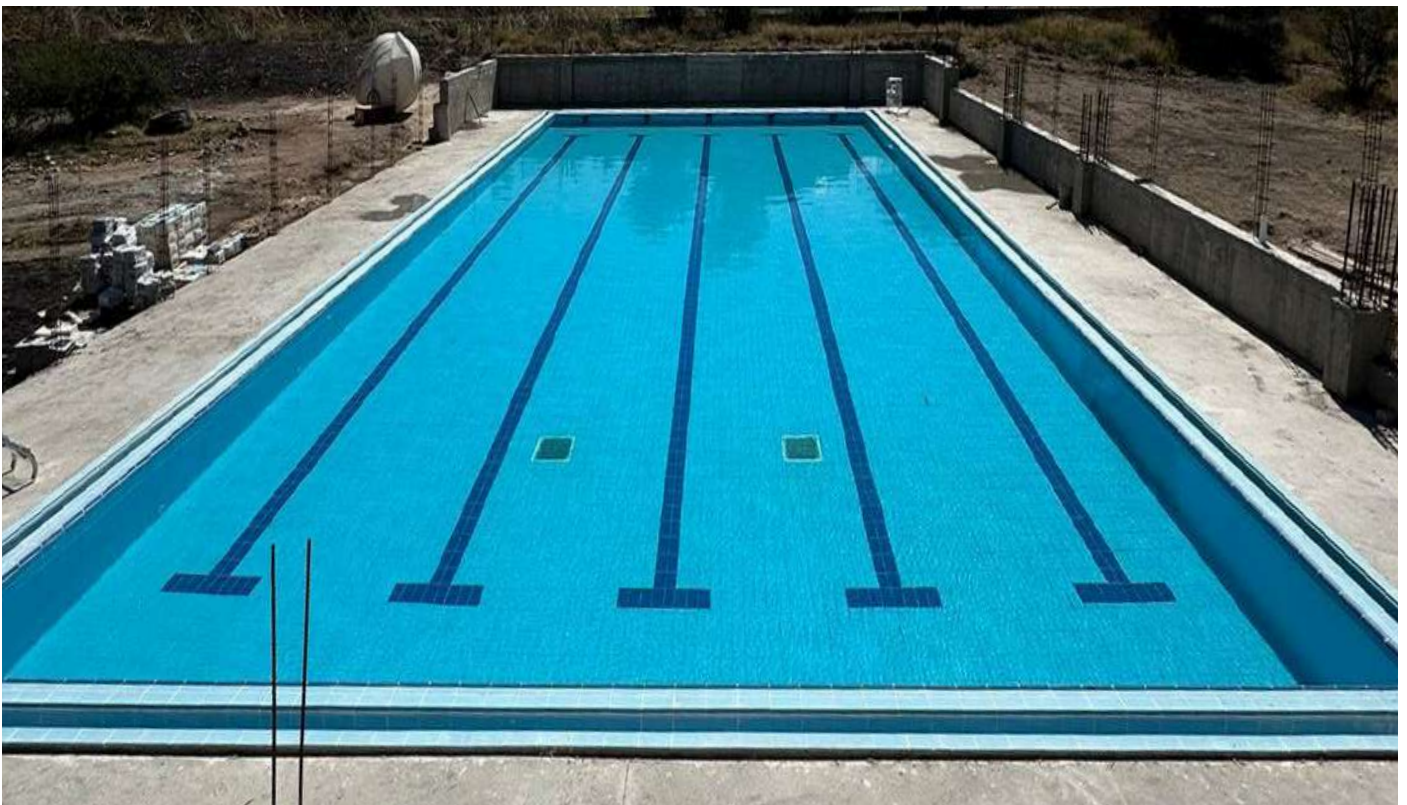

BENEMERITA, MÉXICO



© NDE Group. Los productos en este catálogo son sólo para fines ilustrativos. Las especificaciones pueden variar. NDE Group se reserva el derecho de modificar sus productos sin previo aviso.

NDEPool® es una marca registrada.  
NDE Clima® es una marca registrada

*NDE Group. The products in this catalogue are for illustrative purposes only. Specifications may vary. NDE Group reserves the right to modify its products without prior notice.*

*NDEPool® is a registred brand.  
NDE Clima® is a registred brand.*



**NDE**Group®  
JUST ADD WATER



**NDE**Group®  
JUST ADD WATER

[ndegroup.es](http://ndegroup.es)

[ndepool.com](http://ndepool.com)